

# THE ROLE OF STAINLESS STEELS IN PETROLEUM REFINING



## TABLE OF CONTENTS

Introduction .....	3
Petroleum Refining .....	4
Applications for Stainless Steels ...	6
Crude Distillation .....	6
Fluid Catalytic Cracking .....	9
Delayed Coking .....	13
Hydrotreating .....	16
Catalytic Reforming .....	20
Hydrocracking .....	21
Hydrogen Plant .....	23
Gas Plant .....	26
Amine Plant.....	28
Sulfuric Acid Alkylation .....	30
Sour Water Strippers .....	32
Stainless Steels .....	34
Mechanical Properties .....	35
Types of Corrosion &	
High-Temperature Effects ...	38
Uniform Corrosion .....	38
Pitting .....	38
Crevice .....	38
Intergranular .....	38
Stress-Corrosion Cracking ...	40
Cracking in Polythionic Acid	42
Naphthenic Acid .....	44
Oxidation .....	47
Sulfidation .....	48
Embrittlement .....	52
Carburization .....	53
Hydrogen Attack .....	53
Cooling Water Types .....	54
Fresh Water .....	54
Polluted Fresh Water .....	54
Polluted Salt Water .....	54
Fresh Salt Water .....	54
Cooling Towers .....	54
References .....	56

*Photographs of the refinery appearing in this booklet were supplied by Marathon Oil Company and Ralph M. Parsons Company, the prime contractor.*

## INTRODUCTION

Petroleum refining today is unusually sophisticated in comparison to the single shell stills of the 1800's, and the industry shows every indication of becoming even more complex. Chemical and mechanical engineering advances are being sought to increase product yields and improve plant operating reliability. Methods are being developed to remove potential pollutants from processes as well as products. Changing national interests among oil-producing countries are affecting sources of raw crude supplies.

One result of these changes is a growing emphasis on materials engineering, and greater interest is being shown in the high-alloy, corrosion resistant steels, especially stainless steels, to cope with a wide variety of raw crudes.

Stainless steels are engineering materials with good corrosion resistance in environments containing various compounds of sulfur. They have high strength, excellent fabrication characteristics, and can readily meet a wide range of design demands – load, service life, low maintenance, etc.

The applications for stainless steels in petroleum refining are many and varied. The purpose of this booklet, therefore, is to help materials engineers identify those applications and to provide data to support the use of stainless steels in the high-temperature, corrosive environments that may be encountered.

The stainless steels described in this booklet are the following AISI-numbered stainless steels and commercial proprietary alloys:

AISI Types	Proprietary Stainless Steels
405	20Cb-3
410	439
430	216
440	410S
304 304L	18-2(FM)
309 309S	18-2
310 310S	26-1
316 316L	26-1 Ti
317 317L	18-18-2
321	A286
329	6X
330	Nitronic 50
347	29-4
	29-4-2
	18-18-Plus

Throughout the booklet these materials will be referred to as indicated above, without distinguishing in each instance into which category they belong.

Every effort has been made to insure that the applications described in this booklet reflect general industry practice and that the data are technically correct. However, neither the Committee of Stainless Steel Producers nor the companies represented on the Committee warrant the accuracy of these data.

The Committee of Stainless Steel Producers acknowledges the help by many companies and individuals contributing photographs and/or technical information, especially Ernest Ehmke of Exxon Oil Company for his help in assembling the application data.



*Catalytic reformer section of Marathon Oil Company Garyville Refinery showing Platformer fired heaters.*

*Photograph: Marathon Oil Company  
Ralph M. Parsons Company*

TABLE 1  
Corrosives Found in Many Refining Processes

<b>Sulfur</b>	–present in raw crude, it causes high-temperature sulfidation of metals, and it combines with other elements to form aggressive compounds, such as various sulfides and sulfates, sulfurous, polythionic, and sulfuric acids.
<b>Naphthenic Acid</b>	–a collective name for organic acids found primarily in crude oils from western United States, certain Texas and Gulf Coast and a few Mid-East oils.
<b>Polythionic Acid</b>	–sulfurous acids formed by the interaction of sulfides, moisture, and oxygen, and occurring when equipment is shut down.
<b>Chlorides</b>	–present in the form of salts (such as magnesium chloride and calcium chloride) originating from crude oil, catalysts, and cooling water.
<b>Carbon Dioxide</b>	–occurs in steam reforming of hydrocarbon in hydrogen plants, and to some extent in catalytic cracking. CO <sub>2</sub> combines with moisture to form carbonic acid.
<b>Ammonia</b>	–nitrogen in feedstocks combines with hydrogen to form ammonia-or ammonia is used for neutralization-which in turn may combine with other elements to form corrosive compounds, such as ammonium chloride.
<b>Cyanides</b>	–usually generated in the cracking of high-nitrogen feedstocks. When present, corrosion rates are likely to increase.
<b>Hydrogen Chloride</b>	–formed through hydrolysis of magnesium chloride and calcium chloride, it is found in many overhead (vapor) streams. On condensation, it forms highly aggressive hydrochloric acid.
<b>Sulfuric Acid</b>	–used as a catalyst in alkylation plants and is formed in some process streams containing sulfur trioxide, water and oxygen.
<b>Hydrogen</b>	–in itself not corrosive but can lead to blistering and embrittlement of steel. Also, it readily combines with other elements to produce corrosive compounds.
<b>Phenols</b>	–found primarily in sour water strippers.
<b>Oxygen</b>	–originates in crude, aerated water, or packing gland leaks. Oxygen in the air used with fuel in furnace combustion and FCC regeneration results in high-temperature environments which cause oxidation and scaling of metal surfaces of under-alloyed materials.
<b>Carbon</b>	–not corrosive but at high temperature results in carburization that causes embrittlement or reduced corrosion resistance in some alloys.

## PETROLEUM REFINING

A typical modern petroleum refinery for the primary purpose of producing a complete range of domestic and industrial fuels is illustrated by a block diagram in Figure 1. The refinery also could supply several feedstocks for a present day petrochemical plant and base stocks for lubricating oil production.

Raw crude is separated by fractional distillation into petroleum gas, naphtha (gasoline), middle distillates (kerosene and jet fuel), gas oils (cracking stocks), lubricating oil cuts, and residual oils used for fuel oils, asphalt, or thermal crack stocks (coking).

All the streams from crude distillation are further processed or treated to convert the many fractionated materials to saleable or useful petrochemical stocks. These processes involve the separation of gases and absorption or removal of unwanted deleterious-polluting substances such as carbon dioxide, ammonia and hydrogen sulfide.

Gasoline stocks, and mid-barrel stocks are hydrogenated or hydrotreated to convert organic sulfur and nitrogen to hydrogen sulfide and ammonia for easy removal. Gasoline stocks are catalytically reformed to improve knock rating and combustion characteristics.

Heavier oils, gas oils and vacuum residuum are thermally cracked (pyrolysis-coking), catalytically cracked (fluid catalytic cracking), or hydrogenated (hydrocracked) to increase yields of valuable products.

Olefins can be combined with an aromatic via an acid catalyst – alkylation – to produce a branch chain hydrocarbon of high octane number.

Hydrogen requirements are met by a water gas reforming reaction between steam and methane over an active catalyst at extremely high temperatures.

Waste water is treated and hydrogen sulfide is converted to sulfur.

Raw crude entering a refinery contains several forms of sulfur, water, salts, organic nitrogen and organic acids which split, combine, or convert into numerous corrosive combinations. The primary corrosives are indicated on Figure 1 by being underlined and are briefly discussed in Table 1.

Figure 1

# Petroleum Refinery

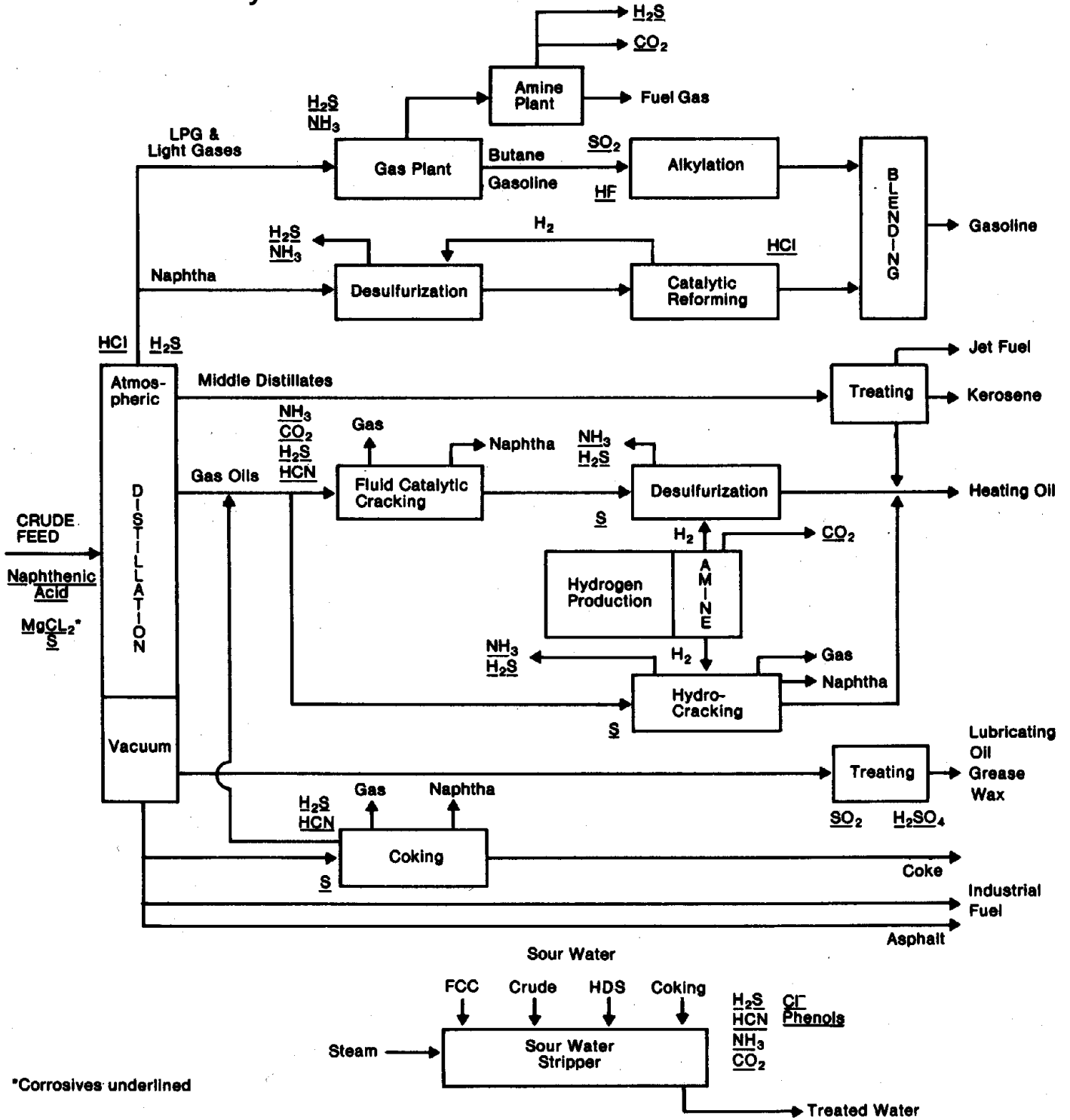
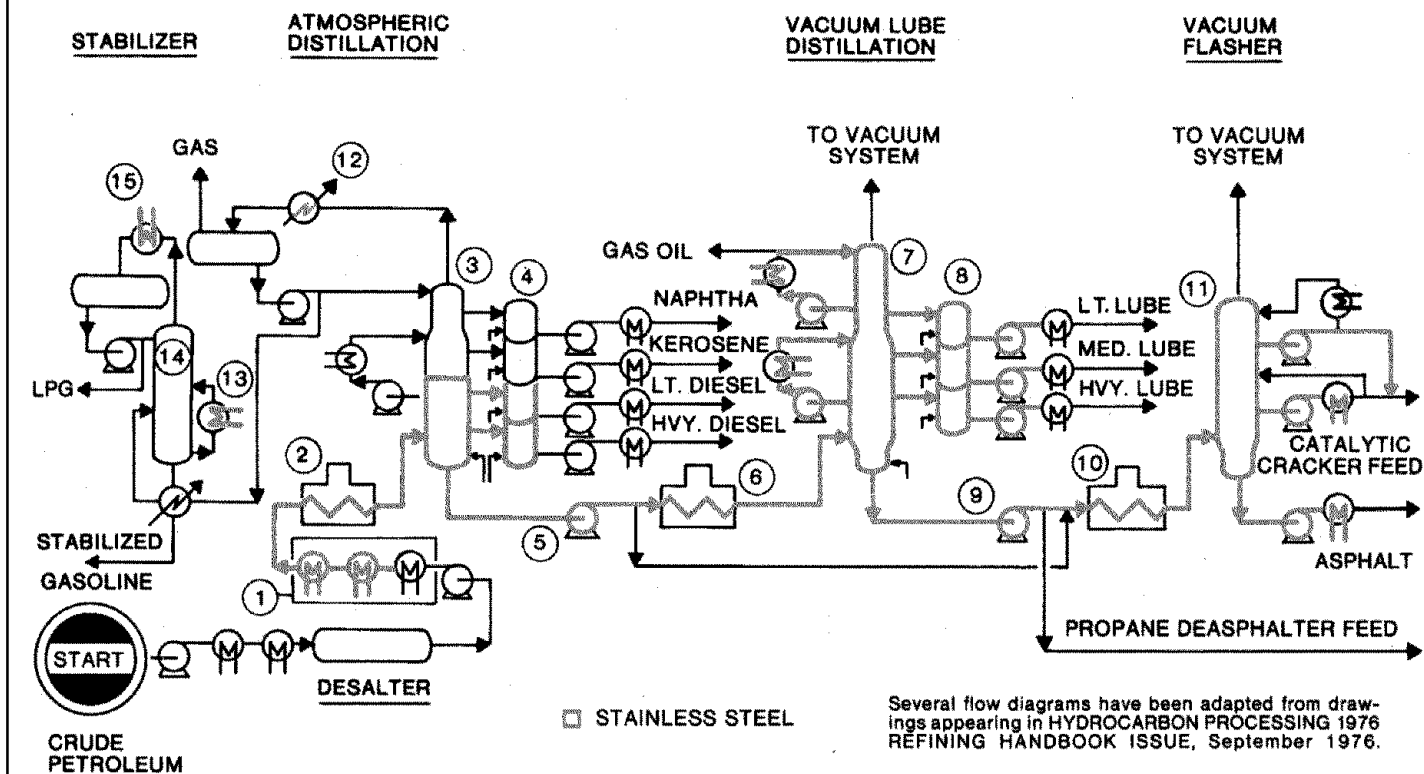

Figure 2

## Crude Distillation



## APPLICATIONS

### Crude Distillation

Figure 2 is a flow diagram of a typical crude distillation unit with one stage of atmospheric distillation and two stages of vacuum distillation. The areas in blue indicate locations for stainless steel use, and the circled numbers refer to process elements discussed in the text.

The crude charge to the unit flows through heat exchangers where heat is recovered from reflux and product streams. Salt content, bottom sediment and water (BS&W) are reduced by the desalter, and the crude is then heated further by hot streams from the atmospheric tower. A direct-fired heater then raises the temperature of the charge to approximately 650-700F (343-371 C).

Effluent from the heater, which at this stage is a combined liquid and vapor stream, is transferred to the atmospheric tower where the vapor is fractionated into a gasoline overhead product and four liquid sidestream products. Circulating pumparound and overhead pumpback streams provide reflux.

After condensing, the overhead gasoline fraction is pumped to a stabilizer where gases, hydrogen sulfide, and ammonia are removed to provide straight run gasoline and LPG. Reboiling heat for the stabilizer is provided by either a direct-fired heater or a shell-and-tube heat exchanger heated by hot residuum.

The four side streams from the atmospheric tower are steam stripped to remove light fractions, cooled, and sent to other units for further processing or to storage. Stripped atmospheric residuum (bottoms) is

pumped through a direct-fired heater to the vacuum towers. At a temperature of about 750-775F (399-413C), the heavy vacuum gas oil and lube oil cuts are separated from the vacuum residuum and, using circulating reflux streams, condensed in the tower. After further cooling, this vacuum gas oil is either sent to storage or to other refinery units. The vacuum residuum is again heated and sent to the vacuum flasher to separate heavy gas oil catalytic cracker feed and asphalt stock.

The stainless steels used most frequently in crude units are Types 405, 410, 304 and 316. Basis for their use is illustrated in Figure 3, which is a summary of data obtained by the American Petroleum Institute. The data show the effect of chromium content on corrosion rates in high-temperature sulfur environments, and that 18-8 stainless (Type 304) has

excellent resistance from 500-750F (260-399C). The 400 Series grades are usually used up to a maximum temperature of 650-700F (343-371C).

With naphthenic acid corrosion there is little advantage to using the straight-chromium stainless steels. With low neutralization numbers, Type 304 has been used with some success,

but the preferred alloy for naphthenic acid is Type 316. There have been instances in which, for example, Type 304, inadvertently used instead of Type 316, corroded away. In crudes containing naphthenic acid, sulfur is always present, and Type 316 has excellent resistance to both.

Type 329 and several other stainless

steels, such as 6X, 29-4 and 26-1, are candidates for the most corrosive applications in overhead condensers. Crudes contain salt, which hydrolyzes to yield hydrogen chloride, and in overhead condensation this results in very aggressive hydrochloric acid. Hydrogen sulfide may also be present, but its effect on corrosion drops off below 450F (232C).

Stainless steels are used in crude distillation units for protection against elevated-temperature sulfidation, primarily, and against attack by naphthenic acids, if present. Naphthenic acids have been reported to be most severe in the 500-650F (288-343C) range with some decrease in corrosivity past 750F (399C) where they are thought to crack.

One factor to consider in the use of stainless steels – in addition to protection in sulfur and naphthenic acid environments – is their minimum scaling tendencies. Crude unit streams go to other refinery processes that have packed catalyst beds, such as desulfurization and hydrocracking. These beds can become plugged if there is much scale or iron in the streams, and plugged beds result in downtime and lost production. Scaling is often not included in reactor and transfer line design corrosion rates, but scaling nevertheless occurs, even at low corrosion rates. Scale can plug heat exchanger tubes and fractionation columns.

The area marked 1, in Figure 2, is the preheat train downstream of the desalter. The first exchanger may have stainless steel tubes for all preheat exchangers because they remain cleaner, offering better heat transfer. Chromium steels have been used, but if corrosion is severe – or if stainless steel tubes are more readily available – they will be used instead. Candidate stainless steels are 304, 430, 410, 405, 26-1 and 18-2.

Point 2 indicates the preheat furnace. Most furnaces are equipped with chromium steels unless the refinery has very corrosive crude. However, stainless steel tubes generate less sulfide scale and have less tendency for coking. Transfer lines from the preheat furnace are normally stainless, Types 304 or 316.

The atmospheric fractionator is shown at 3, and the bottom half of the tower can be stainless-steel-lined up to the

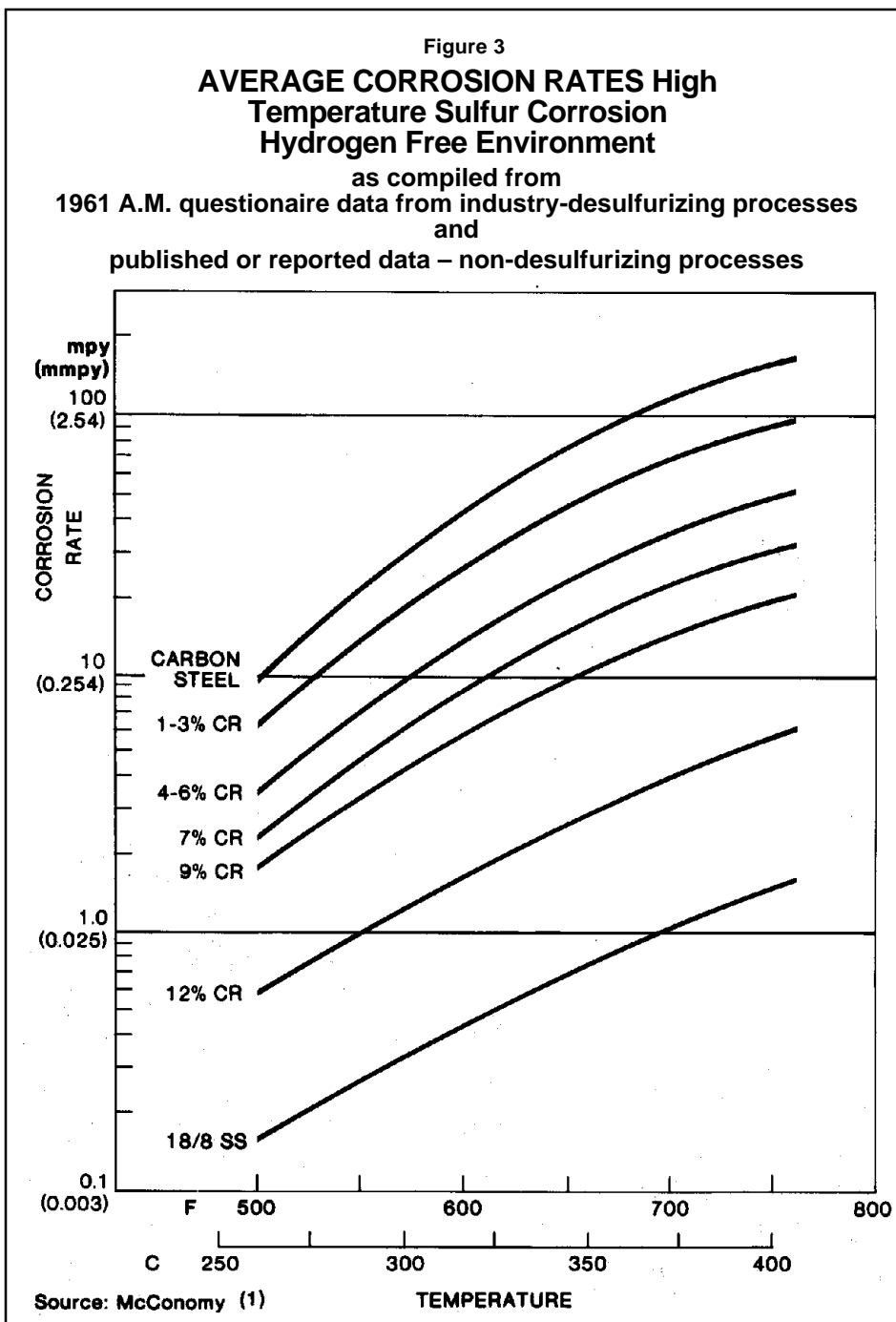

zone where temperatures drop to 550F (288C). This is usually the break-point for using stainless. The cladding materials are Types 410, 304 or 316. Older carbon steel columns that experience corrosion can be strip-lined with stainless. Strip lining can be done a little at a time during a series of short shutdowns.

Trays are also either Types 410 or 304 to the position in the column where the temperature is below 550F (288C).

The column inlet nozzle and flash section is most always lined with stainless because of the high velocity and the high temperature (about 700F-317C) of the flashing crude oil – even though the column may not be stainless.

Draw lines (side cuts) from the column, point 4, leading to the side-stream strippers, are carbon or stainless steels as indicated on the diagram. The strippers may be lined with stainless depending on the corrosiveness of the side streams and whether or not naphthenic acid is present.

Point 5 is the bottom draw line from the atmospheric column to a pump and vacuum tower charge heater. Normally 400 or 300 Series stainless steels are used if corrosion exists, otherwise 5% and 9% chromium steels will suffice. The pumps are usually alloyed.

Since there is no cooling of the bottom draw, unless it is going to storage, the stream is hot though the pump and furnace. Consequently the furnace is usually alloy, especially with a corrosive crude (points 6 and 10). Refineries use Type 304 or 316 seamless and welded tubes in the furnace, in the transfer piping (Figure 4) and the heat exchanger tubes.

The vacuum tower feed line from the furnace is frequently Type 304 or 316, except in low corrosion environments, in which case chromium steels are used. Generally the vacuum tower feed is in the 700F (371C) range, which is most corrosive.

Some refineries have two vacuum towers as indicated in Figure 2; one a vacuum lube tower and the other a catalytic cracker feed. In many plants, both towers are lined with stainless steel

(point 7). Some plants, however, operate with no overhead, other than steam and traces of vapor with a relatively low temperature at the top of the towers, thus minimizing the need for a stainless lining. With hot overhead systems, sulfur compounds can break down, and there is need for stainless steel all the way to the top.

The lube draw lines, point 8, and the strippers from the vacuum tower are often clad or strip-lined with Type 405 or 410. However, if naphthenic acids are present, Type 316 would be necessary. Naphthenic acids tend to concentrate near their boiling range of 550-700F (288-371C) and, on cooling in the strippers or in the pump-around cooler (just to the left of point 7) corrosion can be most severe. Also, velocity may be high in these areas which will increase the attack.

Points 9, 10, and 11 indicate vacuum tower bottoms line, vacuum flasher furnace, and vacuum flasher tower, respectively. Any point in this system can be at 700F (371C), so Type 410 or 304 is generally called for up to the point where cooling takes place in the heat

exchangers following the vacuum flasher.

Point 12 indicates the heat exchanger in the atmospheric fractionator overhead. Hydrogen chloride condenses in this area, forming very aggressive hydrochloric acid. Consequently, the higher alloyed stainless steels, such as 6X and 29-4 are candidate materials.

The stabilizer reboiler (point 13) is a candidate location for stainless steel tubing and shell lining. Since moisture and chlorides collect on the shell side from the reboiled gasoline, the alloy selected has to be resistant to pitting and stress-corrosion cracking. Candidates would be stainless steels 330, 6X, 29-4 and 29-4-2. The shell could be lined with Type 316, since there is no heat flux. The stabilizer column (point 14) would use Type 410, 304 or 316 trays and internals to minimize corrosion and scale accumulations.

The overhead condenser (point 15) could be tubed with 304, 316 or 18-2; any stainless steel except the 400 Series which might suffer excessive pitting in wet condensate.

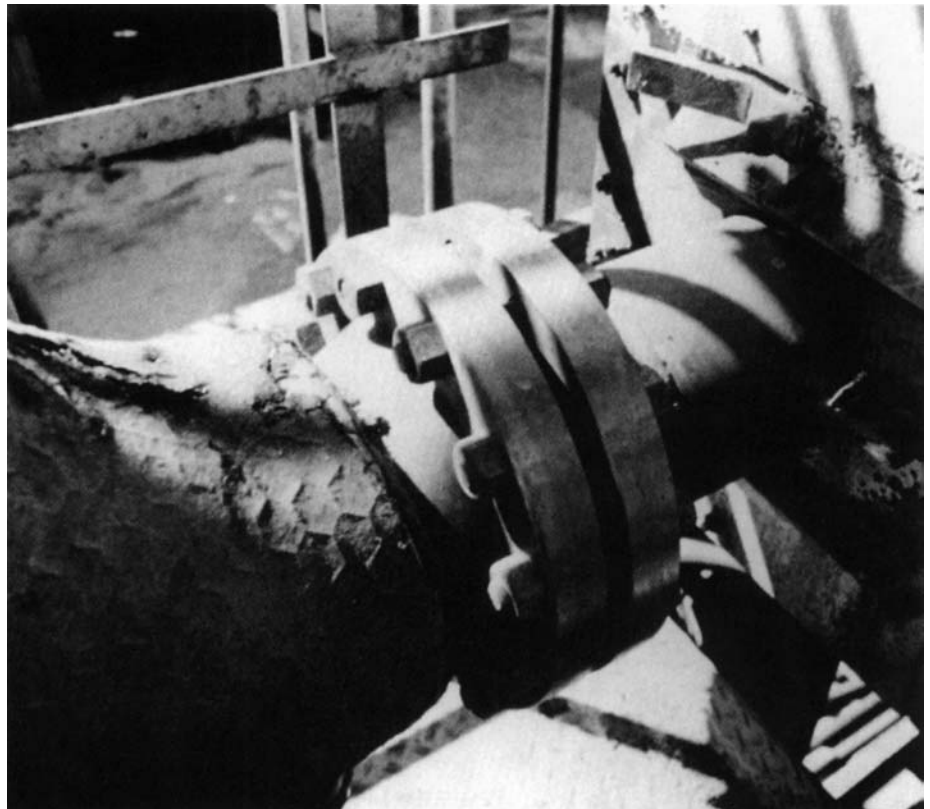
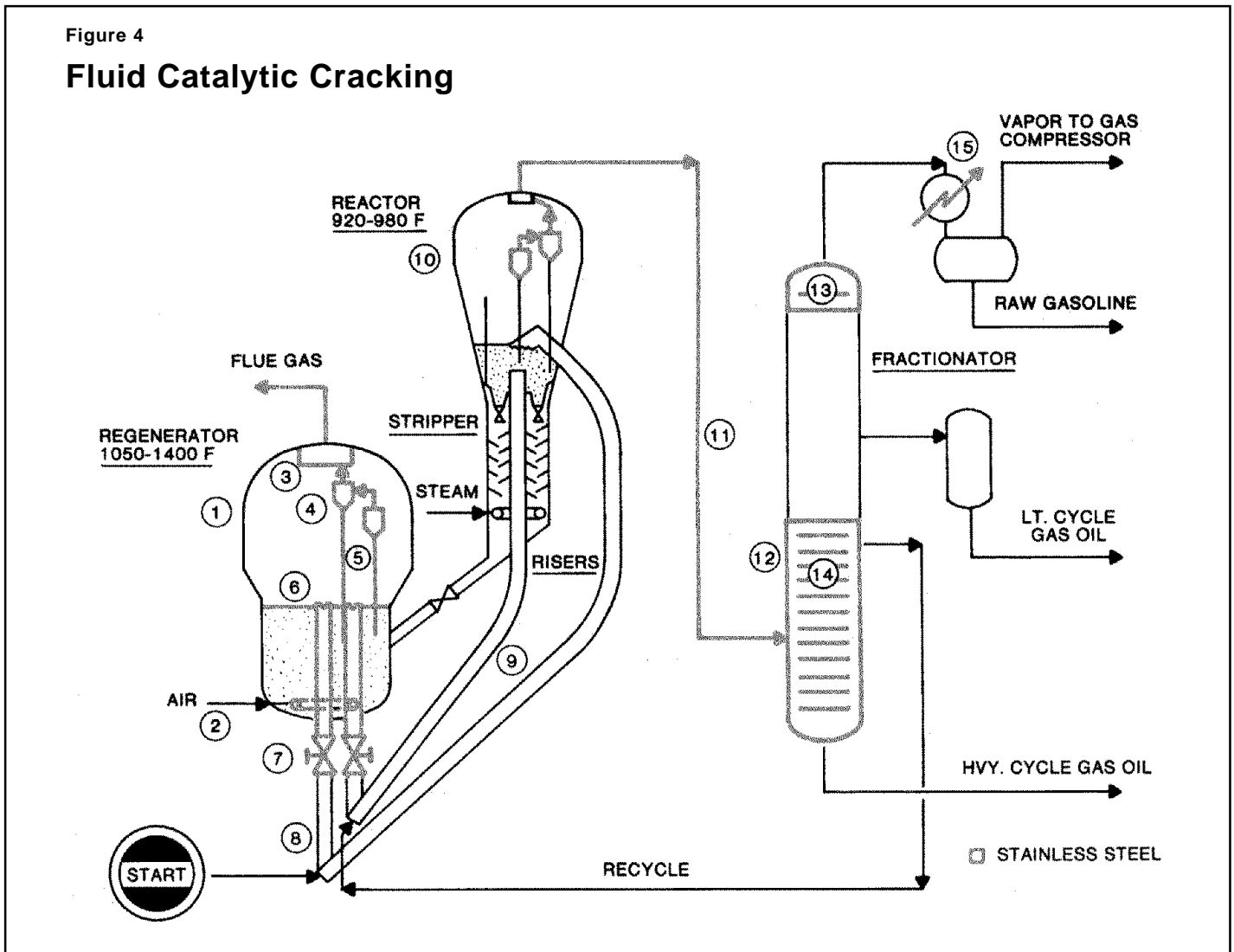

**Figure 4**  
*Type 316 flanges on a 316 outlet tube from a vacuum unit feed heater, point 10 in Figure 2. Tubing can be seamless or welded.*



Figure 4

## Fluid Catalytic Cracking



### Fluid Catalytic Cracking

Fluid catalytic cracking is a modern form of thermal cracking in which an alumina catalyst aids the cracking process. A wide range of both virgin and cracked gas oil fractions from crude distillation, thermal cracking and vis breaking are processed in fluid catalytic cracking units to produce motor fuel blending stocks and petrochemical feedstocks.

The heart of a fluid catalytic cracking unit is the reactor and the risers leading to the reactor. Regenerated catalyst is drawn from the regenerator and sent to the risers where it is contacted with the fresh gas oil charge or recycled oil from the fractionator. The diagram in Figure 5,

which is not necessarily typical of any individual unit, shows two risers going to the reactor; one for fresh feed and the other for recycle oil.

Heat causes both riser streams to vaporize and expand and rise up into the reactor, where temperatures are in the 920-980F (493-527C) range. The overhead stream from the reactor, which includes gas, naphtha, gas oils and heavy oil, is then handled conventionally in a fractionator and subsequently sent to a gas treating plant for separation into LPG, other gas fractions, and gasoline.

In the lower half of the reactor, steam strips product from the catalyst, and the catalyst drops down to the fluidized bed regenerator. In the regenerator,

hydrocarbons flash to raise the temperatures to 1050-1400F (566-760C), which results in the burning of coke and sulfur products off the catalyst. Cyclones separate the catalyst from air and combustion products. Flue gases are ducted to a precipitator for particulate removal and to steam generators and carbon monoxide boilers for recovering heat. The catalyst is funnelled – by gravity and air pressure – down to the risers where the charge enters.

Old regenerators normally operate at 1050E (566C), but as newer catalyst types are used, temperatures may be as high as 1400E (760C). At these temperatures carbon steel lacks sufficient strength and the chromium

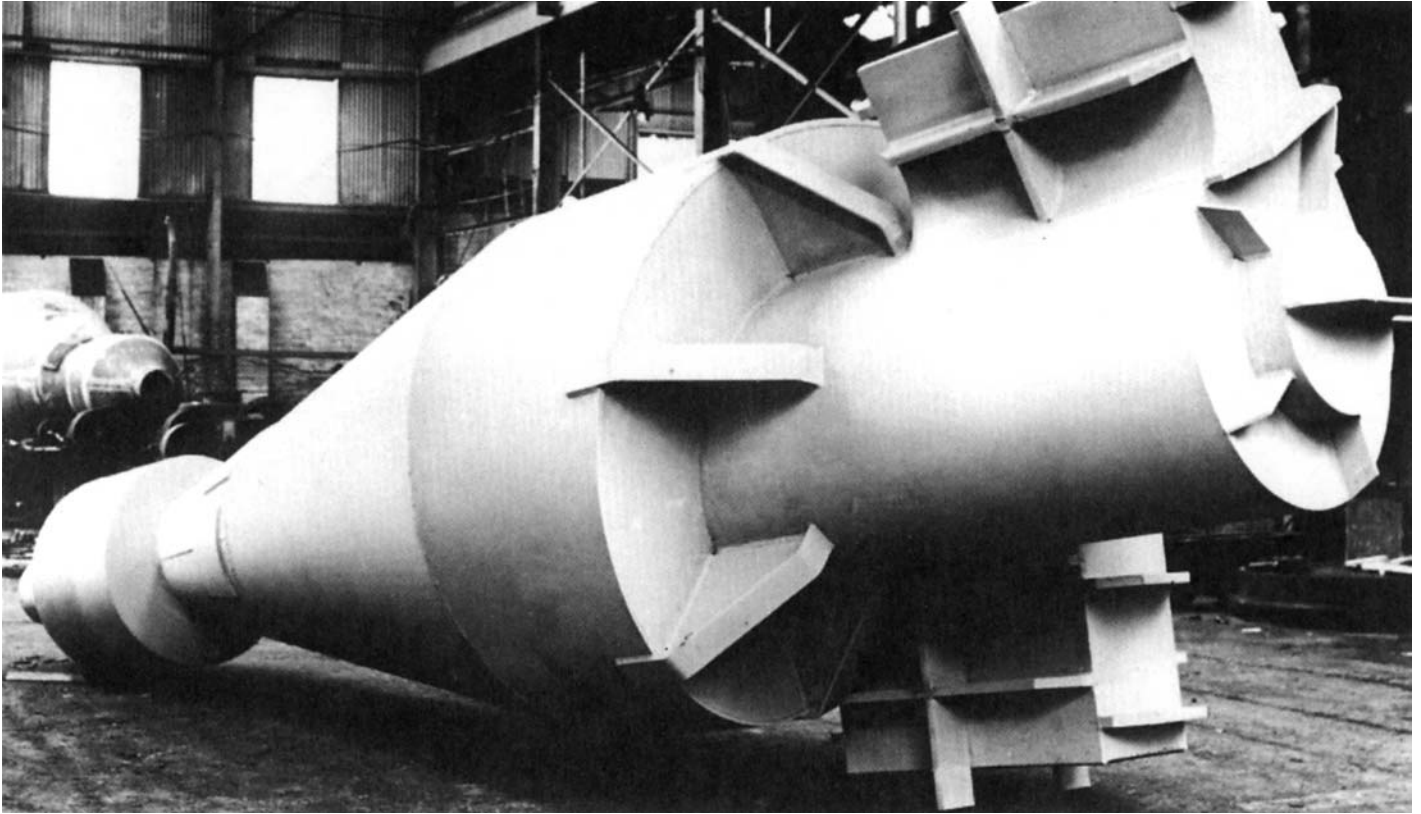

**Figure 6a**  
*Type 304 cyclone for a fluid catalytic cracker.*

**Figure 6b**  
*Cluster of cyclones for fluid catalytic cracker regenerator being assembled and attached to a plenum. Plenums and cyclones are generally made of Type 304 stainless for good elevated-temperature strength and resistance to oxidation.*

*Photographs: Ducon Company*

steels tend to carburize. Consideration must also be given to oxidation and sulfidation.

The stainless steels used in fluid catalytic cracking are mostly Types 304, 321, and 347, although there may be some applications for Types 405 and 410. The austenitic grades have excellent high-temperature strength characteristics\* and are resistant to oxidation and sulfidation.

Point 1 on the diagram (Figure 5) is the regenerator and point 2 is air injection. The diagram shows an air distributor ring to fluidize the catalyst bed, but many units are equipped instead with

\*See page 35 for mechanical property data.

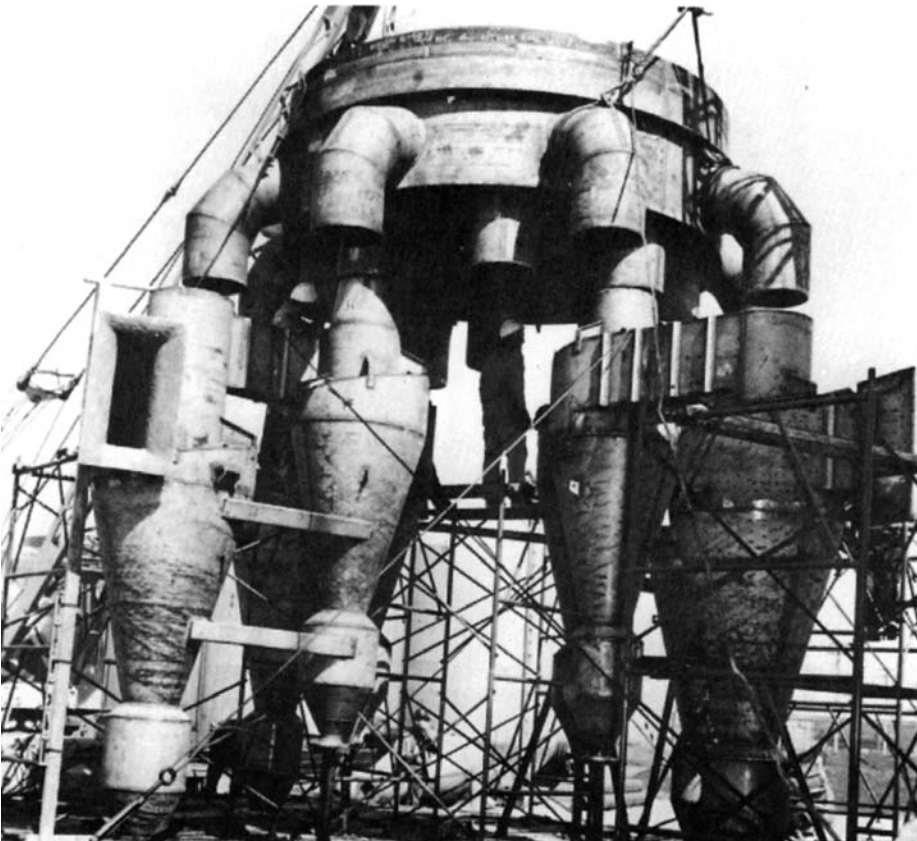

perforated plate distributor grids, Point 6. In either case, Type 304 is generally used for air distribution, even though incoming air may only be 250F (121C). Grids tend to run hot and should be protected from excessive oxidation. Some refiners are applying austenitic stainless steels successfully to grid construction.

Point 3 is a plenum, which is a flue-gas collector welded to the inside of the regenerator. Plenums are generally of Type 304 to match the material in the cyclones (Figures 6a and 6b). The flue-gas line can also be of austenitic stainless steel.

Cyclones are shown at point 4 and dip legs at 5. For the cyclones to have reasonable high-temperature strength and oxidation resistance, they are constructed of Type 304. Dip legs, through which catalyst drops back to the bed, either extend down into the bed, as shown, or they are suspended above the bed and are equipped with trickle valves. Dip legs are normally of Type 304.

Point 6 indicates the overflow valves where the regenerated catalyst drops down to the risers. The overflow valves, transition section between the well and the bottom head of the vessel, and the slide valves (point 7) are usually Type 304 for high-temperature strength. The valve stems should be a high-strength material for high temperatures such as Type 310, 309, or 330.

Point 8 indicates two feed nozzles at the base of transfer lines through which catalyst drops to where the gas oil charge and recycle oil enter the risers. Normally these oil or steam nozzles are stainless steel.

Point 9 indicates the two risers and a transfer line that carry catalyst to the reactor with gas oil charge and to the regenerator for regeneration. These lines are not usually of stainless steel, although stainless steels are used extensively for refractory and insulation hangers and supports. Typical hexsteel or honeycomb supports and wire hangers are shown in Figure 7. In many plants, insulation is placed behind the refractory which keeps the metal walls relatively cool. (Cyclones are also protected with refractory materials, but without insulation.) Sometimes a "one-shot" refractory is applied directly to riser and transfer line walls without

benefit of insulation. Wall temperature, therefore, depends on the nature and thickness of refractory.

At the entry side of the reactor, (point 10, Figure 5) the temperature normally runs 920-980F (493-527C), and this can be a sulfidizing environment. Carbon steel is used to a great extent although there are places where stainless steels are used, such as the cyclone plenum and hanger rods (in both reactor and regenerator). The stainless steels used for hanger rods are Type 304, 321, or 347 with Type 321 being the most popular. The reactor liner and cyclones are frequently of 12% chromium stainless steel, either Type 405 or 410. An important consideration is thermal expansion. A 12% chromium stainless has about the same coefficient of thermal expansion as carbon steel.

The overhead line from the reactor, point 11, is either carbon steel or Type 304, depending on the nature of the process and sulfur content of the feed. If sulfur content is high, stainless steel is usually preferred.

Point 12 is the fractionator, the lower half of which is lined because the operating temperature range is 700-900F (371-482C). These linings historically have been Type 405 or 410, although some are of Type 304. The top, point 13, is usually lined with a higher alloy material because of potential problems with ammonium chloride.

The shed trays and fractionating trays (point 14) in the lower section are usually Type 304 because the ferritic grades may be subject to 885F embrittlement. There hasn't been much use of Type 316, although it is suitable.

Many fractionators have water condensers in the overhead, as indicated at point 15. The materials used in these condensers need resistance to corrosives in the cooling water side and to ammonia, hydrogen chloride, and hydrogen sulfide in the overhead stream side. Brass has been used to some extent; but with high-nitrogen content feed, brass tends to pit. Also, sulfidation is a problem with brass and other copper alloys. Monel has been used where ammonia is not too high. Stainless steels are used, especially the duplex Type 329, which has good resistance to pitting and sulfidation. Also, because of high-nitrogen content, fluid catalytic crackers tend to produce cyanides,

which increase corrosion rates. Stainless steels with a high molybdenum content are required if the cyanide levels are high, such as 316, 317, 6X or 29-4.

There are numerous small parts where stainless steels are used, including valves (Figure 8) and pumps. The recycle stream, for example, contains catalyst, which is quite erosive, so Type 405 or 410 is sometimes used to enhance service life. Most small fittings are Type 304.

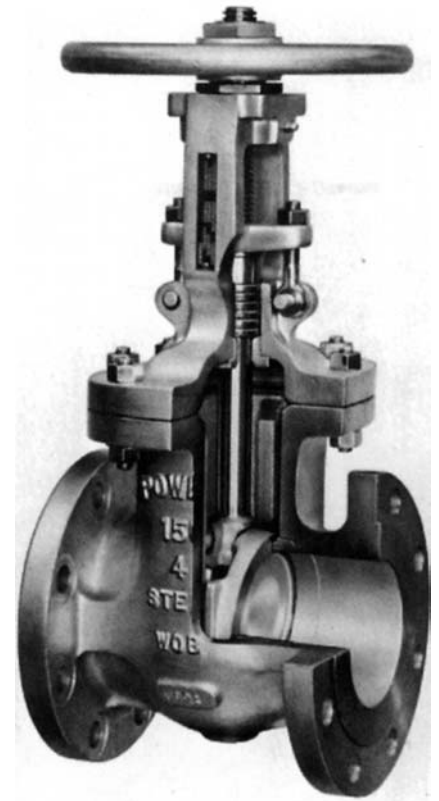

**Figure 8**  
*Numerous small parts throughout a refinery, such as valves, are constructed of stainless steel for resistance to erosion and corrosion. Stainless stems, gates, and seats assure trouble-free operation.*

*Photograph: The Wm. Powell Company*

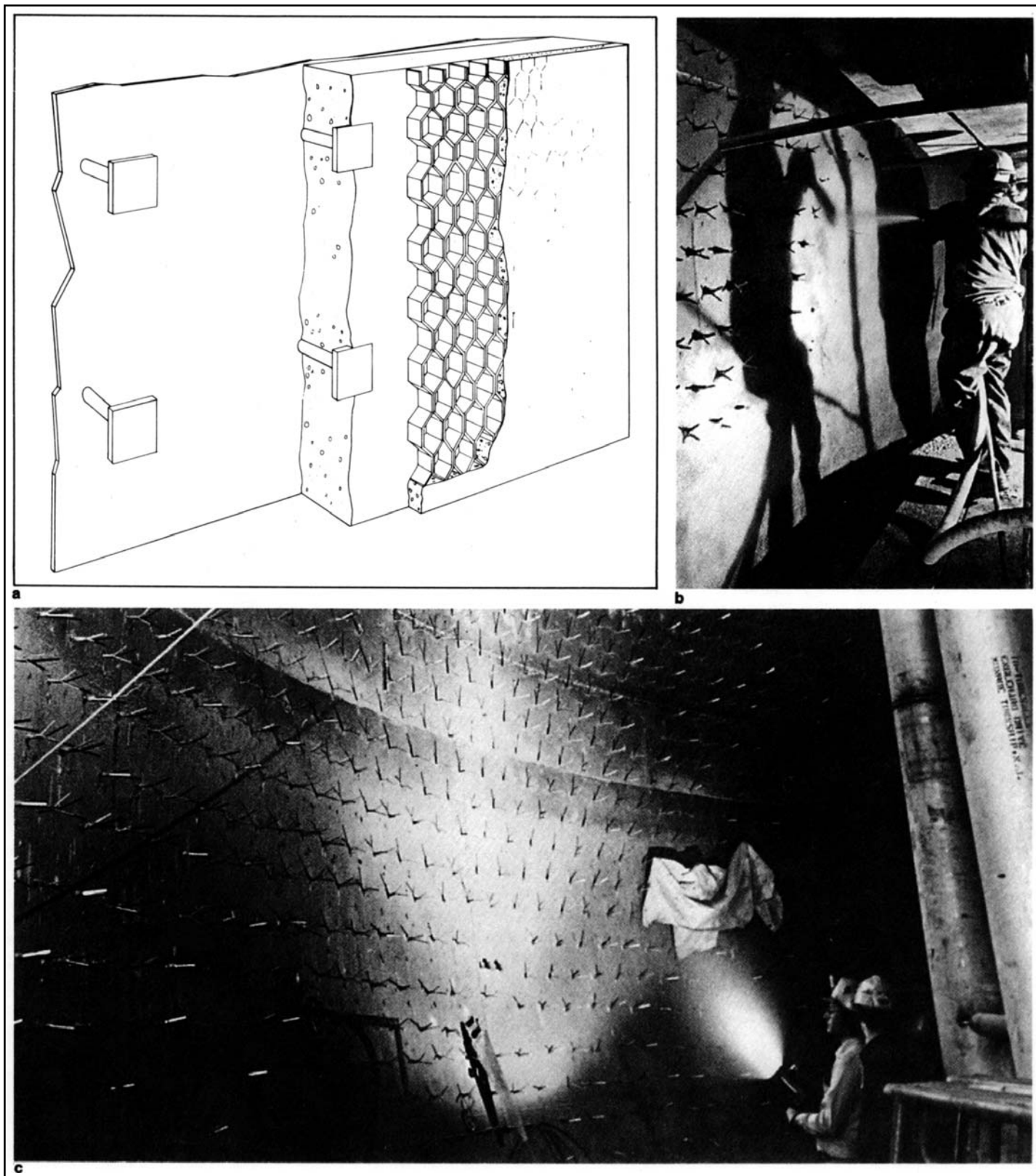

**Figure 7**

Figure 7a shows stainless steel hexsteel refractory support with an under-layer of refractory or insulation as might be used in a fluid catalytic cracker. Insulation behind refractory

keeps metal walls relatively cool. Stainless steel, split-tine anchors (7b) are also used to hold one-shot refractory gunned onto reactor walls (7c). The photographs show refractory being applied to a cat cracker regenerator that

is 55'8" (16.8 m) in diameter and 60' (18.3 m) high.

*Drawing: Harbison-Walker Refractories  
Photographs: General Refractories Company*

Figure 12

## Delayed Coking

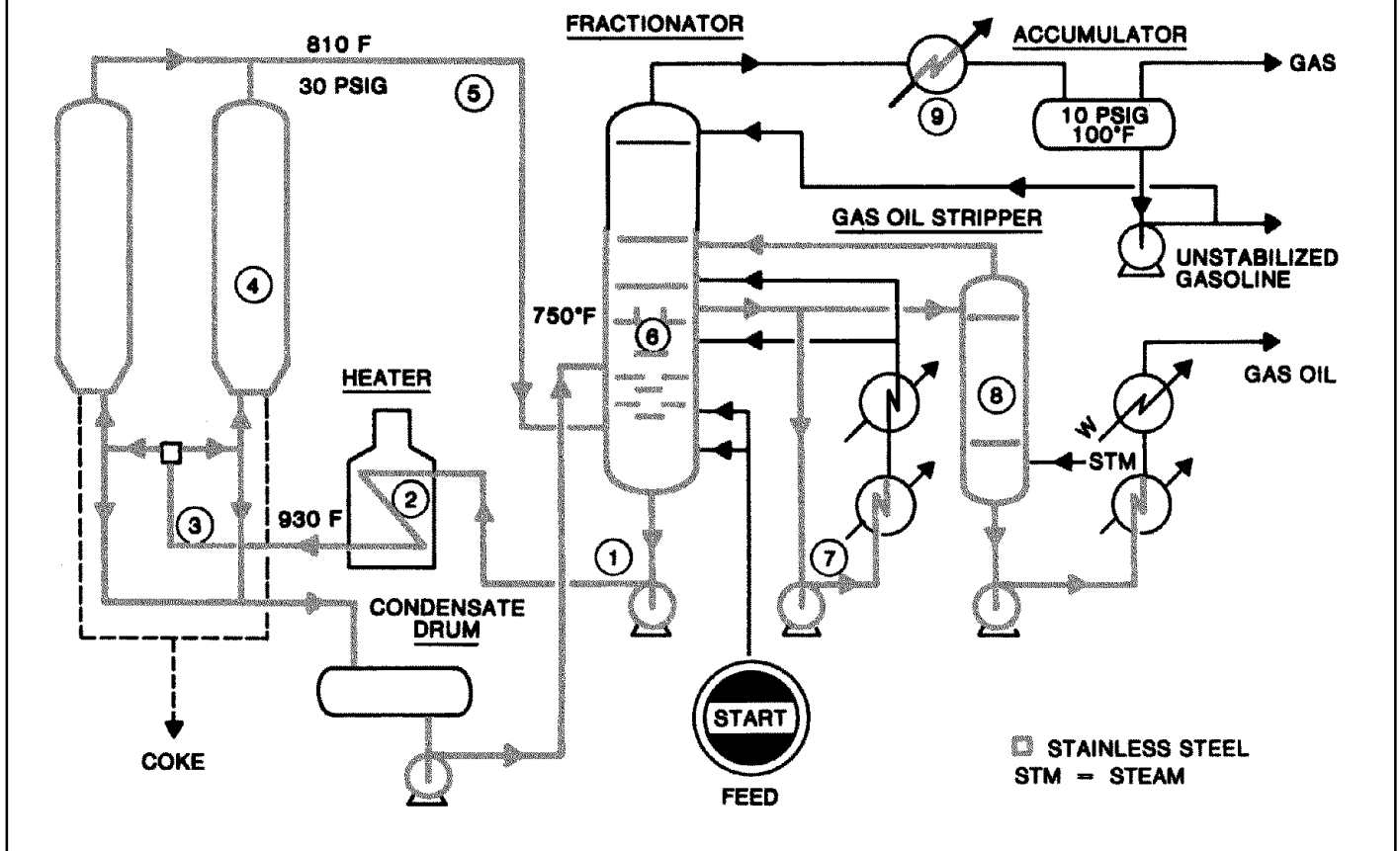

### Delayed Coking

Delayed coking and fluid coking are processes to upgrade reduced crude, tar, asphalt, shale oil and gilsonite into more-valuable distillate products and a coke by-product. Delayed coking is more common than fluid coking. By-product coke is calcined for use in electrodes, batteries, graphite and electrical machinery uses.

A typical coker is diagrammed in Figure 9. Cokers have two, four, or eight coke drums depending on the size of the plant. A four drum coker is most common. Coking heater charge is delivered to one drum while the other drum or drums are being sequentially steam stripped, water cooled, and decoked by hydraulic drilling.

Residuum crude, in a typical refinery, is heated in a fired heater (not shown in Figure 9) and charged to a fractionator

where lighter materials are flashed. The remaining heavy oil, mixed with recycle, is heated to about 950F (510C) in coking thermal cracking heaters and charged to the active drum. The drum slowly fills, in eight, sixteen or twenty four hours, depending on design, with porous coke, while the lighter fractions go overhead as vapor at 850F (483C) to the fractionator for separation into gas, naphtha, gas oil, and recycle resid.

In the fractionator, the stream is split at the 750F (399C) pan trays. Part goes through a cooler and is circulated back to cool the upper area, while the remainder goes to a stripper.

The delayed coker feed is residuum either from the crude unit vacuum tower or the catalytic cracker. The residuals are very heavy oils in which sulfur tends to concentrate. At elevated temperature, the sulfur compounds crack to form

hydrogen sulfide and other active sulfur compounds. Depending on the feed, naphthenic acids may also be present. Although they tend to reduce in the 900F (482C) range, they are not completely eliminated.

To a large extent, most cokers are constructed of Type 410, either clad or solid, except those with high naphthenic acid content, which would normally require Type 316.

There has been some discussion throughout the industry concerning 885F embrittlement of Type 410. Reports have been made concerning 885F embrittlement in coke drum overhead lines where temperatures may reach 810F (432C). In such cases, the lines, which were brittle at ambient temperature, were cracked during coke drilling or knocking to clean the lines. However, at lower temperature, such as

700F (371C) and lower, there is no embrittling phenomenon, so Types 410 and 405 are perfectly satisfactory. Where 885F embrittlement has occurred, replacement with Type 304 or 316 has solved the problem.

The pump for charging the coke drums is shown at point 1; the heater at 2; and the transfer piping at 3. Alloy materials are normally used throughout this equipment because the oil is 750-950F (399-510C) and usually corrosive, particularly if the sulfur compounds are cracked. With noncorrosive oils, 5% chromium steel will serve in the furnace and transfer lines. The pump is either 12% chromium or 18-8 stainless steel. The coke drums, point 4, are clad with Type 410S. 885F embrittlement of Type 410S cladding or backing material is not a problem because the base metal, carbon-molybdenum or chromium-molybdenum steel, remains ductile.

Effluent from the coke drums, point 5, is about 800F (427C) which requires 12% chromium stainless steel or better. If the corrosion is aggressive, Type 304 or 316 will have to be used. Type 304 is the more likely candidate because there is a large amount of diluent in the naphthenic acids.

The flow recirculates between the fractionator, point 6, and the coke drums, with cooling provided partly by incoming feed and partly by recycle taken from the pan tray at 750F (399C). At this temperature, naphthenic acids require Type 316. Without naphthenic acid, Type 410 is applicable throughout the panies aluminize stainless steels for added protection against polyrovided there is no condensation.

The first recycle heat exchanger, point 7, is the hottest, so the tubes would be either Type 410 or 304. This exchanger could also be tubed with stainless steel 26-1, 26-1S, 18-2 and 29-4, all of high chromium content. The steam stripper, point 8, which removes any light hydrocarbons and hydrogen sulfide, would be alloyed steel for corrosive service, including trays, the vessel, and the return line back to the fractionator.

The gas oil stripper bottoms, which is one of the products, may require Type 410, 304 or 316 for the pump, piping, and hottest exchanger. Type 410 is generally favored because there is an effort to reduce the use of low-chromium steels.

The chromium steels tend to introduce dissolved iron (as iron naphthate) and scale into the feed for the hydrocracker or desulfurizer, which increases plugging of the reactor catalyst beds.

The fractionator overhead condenser, point 9, could be tubed with stainless steels 304, 316, 18-2, 6X, 29-4 and 26-1. The choice would depend on the nature

of the cooling water on one hand and the corrosivity of the vapor on the other. If substantial cyanide were present in the vapor, then alloys 6X or 29-4 should be considered. If the overhead contained just hydrogen sulfide, ammonia, and small quantities of cyanide, then all the stainless steels listed would appear to be suitable.

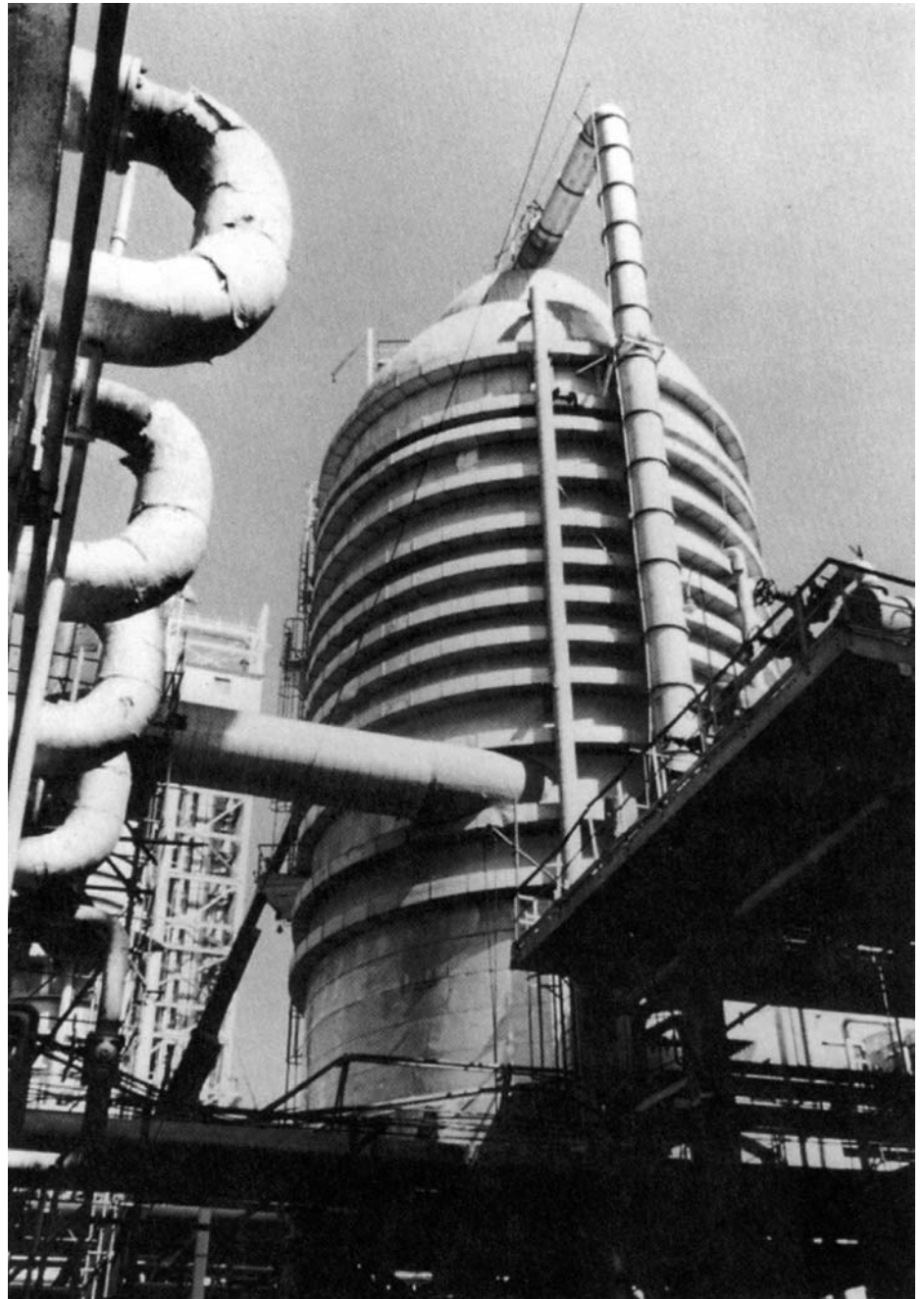

*Vacuum distillation tower has Type 316 stainless steel lining and trays for protection against corrosion by naphthenic acid. Cross-over elbows (left foreground) are also Type 316.*

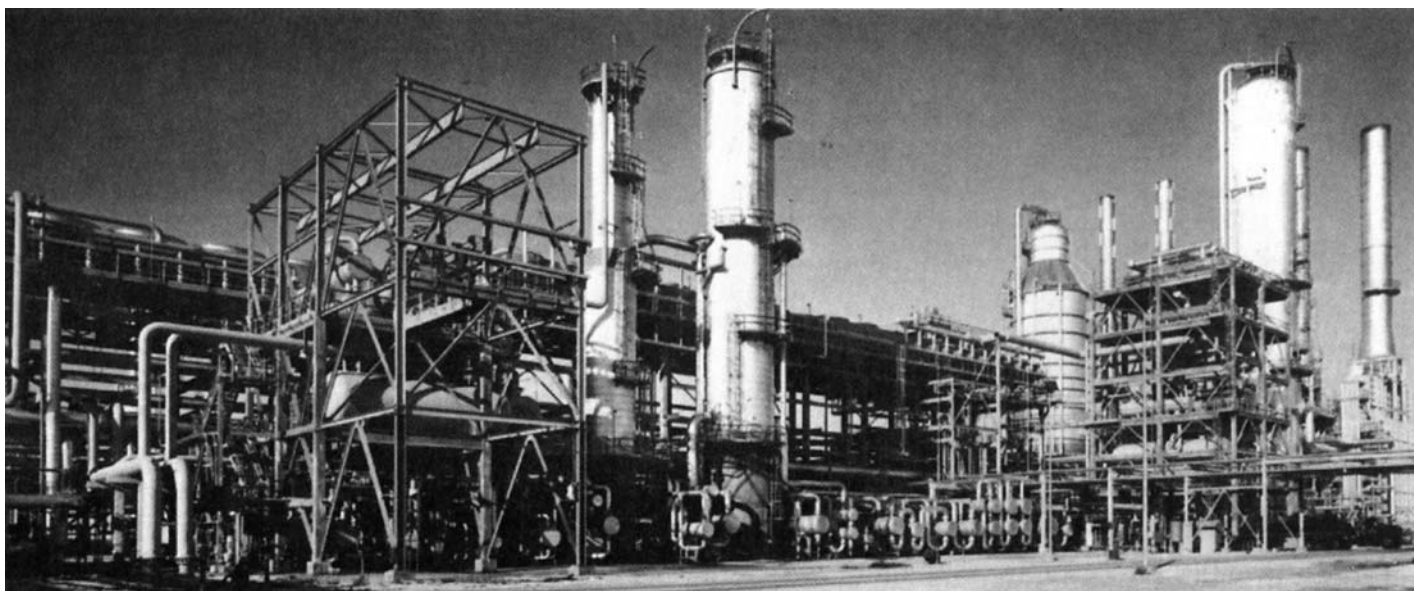

The crude distillation unit of the Marathon Oil Company Garyville Refinery has a design capacity of 200,000 BPD.

Photograph: Marathon Oil Company  
Ralph M. Parsons Company

TABLE 2

Chemical Composition, Per Cent\*

AISI Type	Chromium	Nickel	Carbon	Manganese	Phos-phorus	Sulfur	Silicon	Other
405	11.50/14.50	—	0.08	1.00	0.040	0.030	1.00	0.10/0.30 Al
410	11.50/13.50	—	0.15	1.00	0.040	0.030	1.00	
430	16.00/18.00	—	0.12	1.00	0.040	0.030	1.00	
440C	16.00/18.00	—	0.95	1.00	0.040	0.030	1.00	0.75 Mo
304	18.00/20.00	8.00/10.50	0.08	2.00	0.045	0.030	1.00	
304L	18.00/20.00	8.00/12.00	0.030	2.00	0.045	0.030	1.00	
309	22.00/24.00	12.00/15.00	0.20	2.00	0.045	0.030	1.00	
309S	22.00/24.00	12.00/15.00	0.08	2.00	0.045	0.030	1.00	
310	24.00/26.00	19.00/22.00	0.25	2.00	0.045	0.030	1.50	
310S	24.00/26.00	19.00/22.00	0.08	2.00	0.045	0.030	1.50	
316	16.00/18.00	10.00/14.00	0.08	2.00	0.045	0.030	1.00	2.00/3.00 Mo
316L	16.00/18.00	10.00/14.00	0.030	2.00	0.045	0.030	1.00	2.00/3.00 Mo
317	18.00/20.00	11.00/15.00	0.08	2.00	0.045	0.030	1.00	3.00/4.00 Mo
317L	18.00/20.00	11.00/15.00	0.030	2.00	0.045	0.030	1.00	3.00/4.00 Mo
321	17.00/19.00	9.00/12.00	0.08	2.00	0.045	0.030	1.00	5XC Min. Ti
329**	25.00/30.00	3.00/ 6.00	0.10	2.00	0.040	0.030	1.00	1.00/2.00 Mo
330	17.00/20.00	34.00/37.00	0.08	2.00	0.040	0.030	0.75/ 1.50	
347	17.00/19.00	9.00/13.00	0.08	2.00	0.045	0.030	1.00	10XC Min. Cb+Ta

\*Maximum unless noted otherwise.

\*\*For tubing and plate, see ASTM Specification A-268.

Figure 10  
**Hydrodesulfurizers & Hydrofiners**

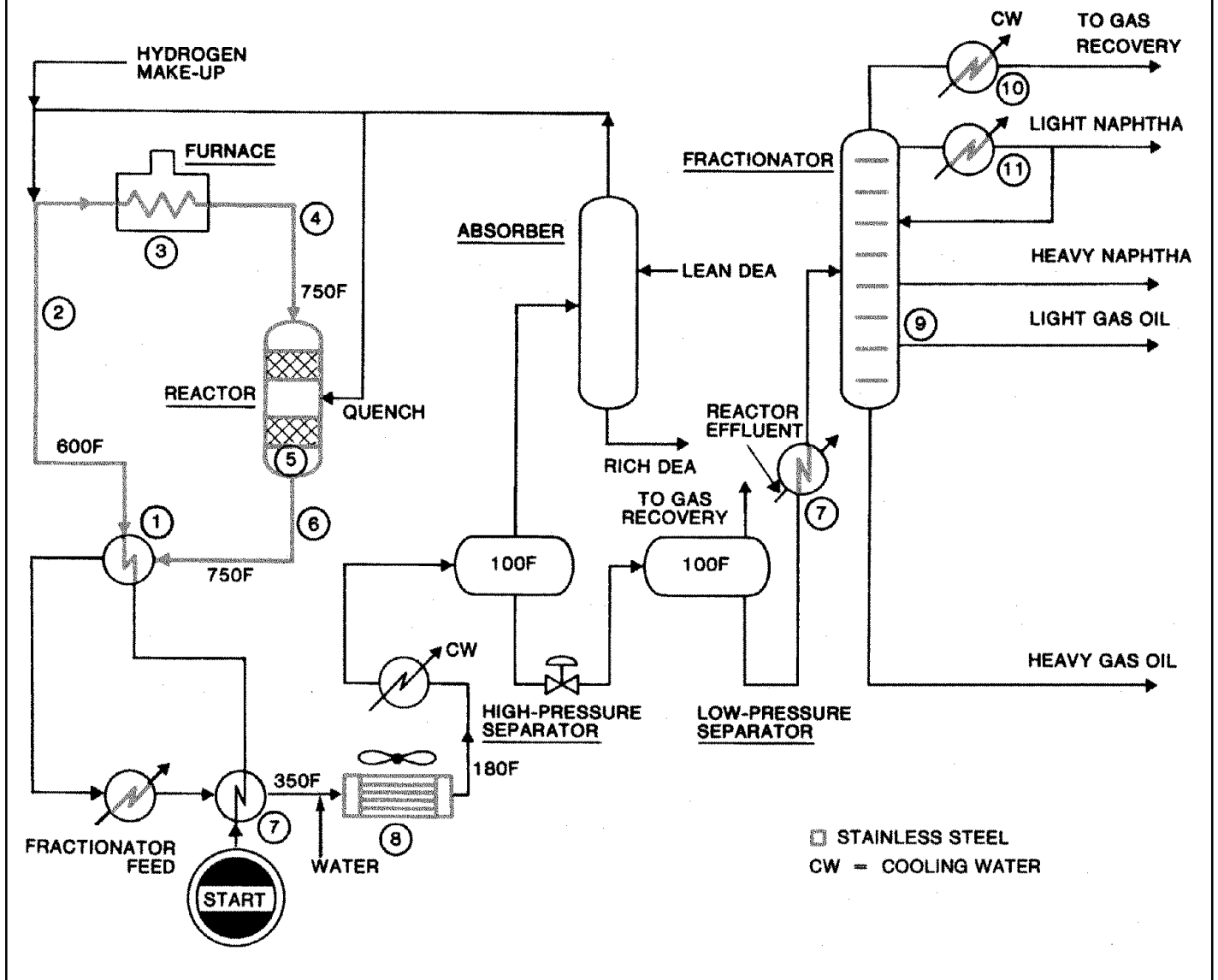

**Hydrotreating  
 (Hydrodesulfurization and  
 Hydrodenitrogenation)**

Hydrotreating processes are catalytic processes using hydrogen to perform a very mild hydrogenation of sulfur and nitrogen in hydrocarbons. Sulfur and nitrogen are converted to hydrogen sulfide and ammonia for easy separation. The catalytic reaction over the cobalt and/or nickel-molybdenum catalyst occurs from 700F (371C) to 775F (415C). At higher temperatures, too

much coke would form, and catalyst life between regenerations would be too short.

Thus, naphtha, jet fuel, diesel, gas oils, lube oils and fuel oils can be treated to remove two deleterious substances.

As shown in Figure 10, the basic process involves one or more fixed-bed reactors, a fired heater, a source of hydrogen, a system for removing hydrogen sulfide and ammonia, and a fractionator where the stream is separated into naphtha, middle distillate and fuel oil. The gasoline goes to a

catalytic reformer and the gas oil to a catalytic cracker.

Hydrodesulfurizers are low-pressure units that operate in the area of 700 psi (4.8 MPa) with some heavy oils as low as 300 psi (2.1 MPa). Hydrofiners are defined as high-pressure units for heavy oil streams, and they operate from 1200-3000 psi (8.3-20.7 MPa). Reactor temperatures are approximately 700F (371C).

The corrosive substances to be formed in hydrodesulfurizers are hydrogen sulfide (in the presence of hydrogen at



elevated temperature), ammonia and ammonium hydrosulfide (at low temperatures), and polythionic acids (formed from metal sulfides, air and moisture during shutdowns). Ammonia chlorides are often present. Hydrogen at high temperature and pressure attacks the structure of ordinary steel causing embrittlement and reduction of mechanical properties.

As discussed earlier, stainless steels are preferred for sulfur-containing environments over 550F (288C), and for the fact that they show less tendency to coke. The stabilized grades are used to prevent sensitization and minimize the possibility of polythionic acid stress-corrosion cracking during shut down. The stainless steels used in hydrodesulfurization and hydrofining are Types 405, 410, 430, 304, 321, 347 and 308 for weld overlay. The choice of material, to a great extent, depends on the amounts of hydrogen sulfide and hydrogen, the temperature, and the elevated-temperature properties of the candidate alloys. At low temperatures, when moisture is present, the choice revolves around chemical corrosion resistance, stress-corrosion resistance and corrosion-erosion resistance.

Starting with the feed-effluent heat exchangers, point 1, when the temperature of any components, i.e. tubes, tube sheets, shell and support baffles, is over 550F (288C), a stainless steel is chosen. The most common choice for tubes is Type 347, but Types 321, 304 and 430 have been used. The reason, of course, for stainless is to resist high-temperature sulfidation. The channel section or pill box, as it is sometimes called, may be built of Type 347, 321 or 304, either solid plate or stainless clad chrome-moly steel.

The hot piping from the feed-effluent exchanger, point 2, is fabricated from Type 347, 321 or 304 stainless steel. At this point, recycle and make-up hydrogen join the feed stream. The presence of hydrogen reduces the tendency for coking. Fired heater tubes (point 3) are most frequently Type 347, 321 or 304. Chrome steels, such as 5% and 9% chromium are used, but they show higher corrosion rates resulting in scale (Figure 11), which frequently finds its way to the reactor and plugs the inlet. Roughened surfaces tend to build up coke more easily than smooth surfaces.

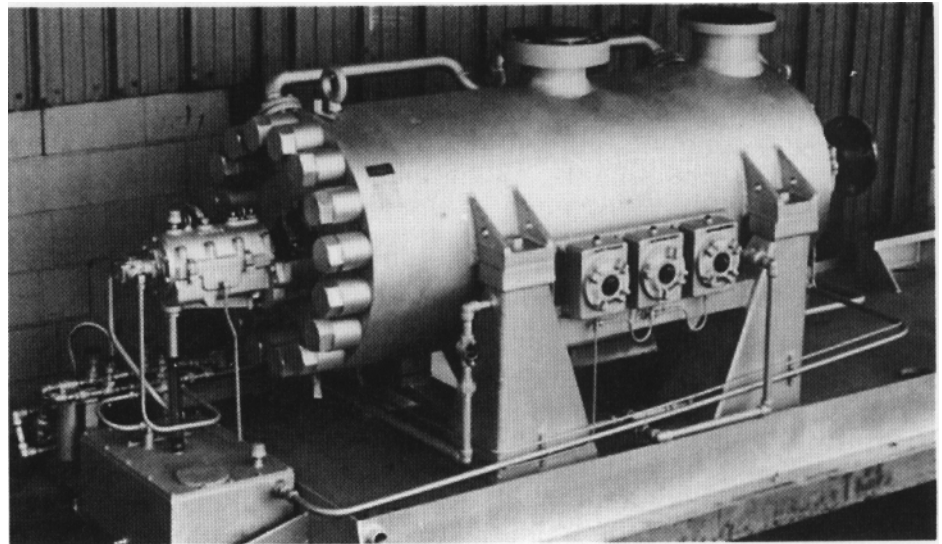

*A typical 12-stage hydrocarbon pump, that might be used as a hydrocracker charge pump. Many wetted components are stainless steel for strength and corrosion resistance.*

*Photograph: Bingham-Willamette Company.*

TABLE 3								
Representative Mechanical Properties								
Stainless Steel Sheet, Annealed								
AISI Type	UNS No.	Tensile Strength		Yield Strength (Offset 0.2%)		Elongation in 2" (50.80 mm)	Hardness Rockwell	
		ksi	MPa	ksi	MPa	%		
405	S40500	65	448	40	276	25		B75
410	S41000	70	483	45	310	25		B80
430	S43000	75	517	50	345	25		B85
440C*	S44004	125	862	100	689	7		C24
304	S30400	84	579	42	290	55		B80
304L	S30403	81	558	39	269	55		B79
309	S30900	90	621	45	310	45		B85
309S	S30908	90	621	45	310	45		B85
310	S31000	95	655	45	310	45		B85
310S	S31008	95	655	45	310	45		B85
316	S31600	84	579	42	290	50		B79
316L	S31603	81	558	42	290	50		B79
317	S31700	90	621	40	276	45		B85
317L	S31703	86	593	38	262	55		B85
321	S32100	90	621	35	241	45		B80
329	S32900	105	724	80	552	25		B99
330	N08330	80	552	38	262	40		
347	S34700	95	655	40	276	45		B85
*Bar Properties								

The same alloys mentioned above are chosen for reactor piping at points 4 and 6.

Low-pressure reactors, point 5, that operate around 700 psi (4.8 MPa) are clad with Type 347, 321, 304L or 410, but high-pressure units are built like hydrocrackers with a more economical weld overlay, either Type 308 or 347. Bed supports, distributor trays, thermowells and scale baskets inside the reactors

are always stainless steel, Type 347, 321 or 304.

Reactor effluent exits through Type 304 or 347 pipe to the shell side of the feed heat exchangers. The shell is normally clad, Type 304, because it is of small size and probably not thick enough for weld overlay. The nozzle faces are weld overlay and any internal parts, such as bundle supports, are Type 304. The tube sheet may be solid, clad, or weld

overlay stainless. In some cases, tube sheets and vessel nozzles are explosive bonded Type 304, 321, or 347.

Generally speaking, when 300 Series stainless steels are selected for equipment in and around the reactor system, the stabilized Types 347 and 321 are preferred. They provide better security in avoiding polythionic acid stress corrosion cracking (2) (3) (4)\*.

Polythionic acid will cause

**TABLE 4**  
**Chemical Composition, Per Cent \***

Alloy	Chromium	Nickel	Carbon	Manganese	Phosphorus	Sulfur	Silicon	Other
20Cb-3	19.00/21.00	32.50/35.00	0.06	2.00	0.035	0.035	1.00	2.00/3.00 Mo 3.00/4.00 Cu Cb+Ta 8XC min./ 1.00 max.
439	17.75/18.75	.50	.07	.20/.50	.030	.030	.20/ .50	Ti 12XC Min. .85 Max.
216	17.50/22.00	5.00/7.00	.08	7.50/9.00	.045	.030	1.00	2.00/3.00 Mo .25/ .50 N
410S	11.5 /13.5	.60	.08	1.0	.04	.03	1.0	
18-2 (FM)	17.50/19.50		0.08	1.25/2.50	0.040	0.15/ 0.40	1.00	1.50/2.50 Mo
18-2	17.5/19.5	1.00	0.025	1.00	0.040	0.030	1.00	1.75/2.50 Mo Min. Ti+Nb 0.20 +4 (C+N)
26-1	25.0/27.5	0.5	0.01	0.40	0.02	0.02	0.4	0.75/1.50 Mo
26-1 Ti	25.0/27.5	0.5	0.06	0.75	0.040	0.020	0.75	.75/1.50 Mo Min. Ti-7 (C+N)
18-18-2	17.00/19.00	17.50/18.50	0.08	2.00	0.030	0.030	1.50/ 2.50	
A286	13.50/16.00	24.00/27.00	0.08	2.00			1.00	1.00/1.75 Mo 1.90/2.30 Ti 0.10/0.50 Va 0.35 A1 0.003/0.010 B
6X	20.00/22.00	23.50/25.50	.035	2.00	0.030	0.015	.75	6.00/7.00 Mo
Nitronic 50	20.5/23.5	11.5/13.5	.06	4.0/6.0	.040	.030	1.00	1.5/3.0 Mo .10/.30 Cb .10/.30 Va .20/.40 N
29-4	28/30	.15	.0100	.30	.025	.020	.20	3.5/4.2 Mo .0200 N .0250 C+N
29-4-2	28/30	2.0/2.5	.0100	.30	.025	.020	.20	3.5/4.2 Mo .0200 N .0250 C+N
18-18-Plus	17.00/19.00		0.15	17.00/19.00	0.040	0.040	1.00	0.75/1.25 Mo 0.75/1.25 Cu 0.40/0.60 N
*Maximum unless noted otherwise								

intergranular corrosion cracking or stress-corrosion cracking of sensitized and mildly stressed austenitic stainless steel. Types 304 and 316 can be sensitized from welding, from vessel stress relief, from hot regeneration temperatures, and from long periods of time at relatively low temperatures, about 775F-800F (410-427C). Polythionic acid does not normally cause corrosion to fully annealed, non-sensitized stainless steel. The industry, by-and-large, prefers the stabilized grades because they are very difficult to sensitize.(3)

For those systems that have Type 304 or 316 in place, the industry - through the National Association of Corrosion Engineers (NACE) Recommended Practice RP-01-70 - advises the use of acid neutralizing washes and/or the addition of ammonia to purge nitrogen when cooling and isolating equipment.

Failures due to polythionic acid intergranular cracking have been reported in piping, cladding, tube sheets, fired heater tubes and heat exchanger tubing.(4) The frequency of reports has diminished markedly once the criterion and mitigation steps have been understood.

"U" bend style heat exchangers are very common in feed-effluent exchanger service for economy reasons. Many materials engineers desire to relieve bending stresses to minimize the possibility of chloride-induced stress corrosion via inadvertent water entry with the feed. A full solution anneal at 1850F (1010C) to 1950F (1066C) of individual "U" bends is suggested to relieve stress of Type 304 or 316. A stress relief at 1550F (843C) to 1650F (898C) will sensitize these grades and render them prone to polythionic acid attack. However, Types 347 and 321 can be stress relieved at 1650F because they will not sensitize.

The fractionator feed exchanger, point 7, has been tubed with Types 304, 410, and 430. The effluent is just hot enough at this point in its cooldown, to heat the fractionator feed that still contains hydrogen sulfide and thus cause sulfidation in tubes of lesser alloys.

The air cooler, shown at point 8, in carbon steel frequently suffers corrosion from a compound present at high pressure known as ammonium

hydrosulfide.(5) Type 330 and similar proprietary stainless steels are being successfully utilized at this point to provide protection from chloride stress-corrosion cracking.

The trays in the fractionator (Point 9) are normally Type 410, and on occasion Type 304. The gas cooler and naphtha coolers (points 10 and 11) are candidates for 304, 316, 18-2, or 26-1 if long life and cleanliness are desired in the overhead system. Stainless steels 304 and 18-2 would be used for modestly aggressive waters, while 316 and 26-1 would be better suited to high-chloride cooling waters.

There are a few other places for stainless in hydrodesulfurizers and hydrofiners. For instance, if the feed to the unit comes from storage, a carbon steel pump will be adequate. However, plants like to tie units together to avoid having to cool down and heat up process streams. Consequently the feed pump, if hot, will usually be a 12% chromium stainless, although this will be cast except for wear rings, seals, shafts or

shaft sleeves and impellers.

In the pressure let-down area, the rich DEA tends to flash, so stainless valves and piping manifolds would normally be used. Valves throughout the plant, instrument systems and sampling systems require stainless.

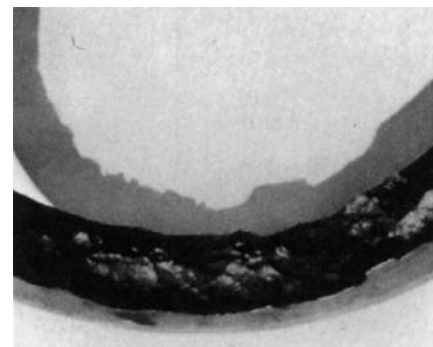

**Figure 11**  
Section of 5% chromium pipe showing effects of sulfidation at elevated temperature. High corrosion rates result in scaling, which frequently leads to plugging of downstream units. Roughened surfaces build up coke more readily than smooth surfaces.

TABLE 5								
Representative Mechanical Properties								
Stainless Steel Sheet, Annealed								
Alloy	UNS No.	Tensile Strength		Yield Strength (Offset 0.2%)		Elongation in	Hardness	
		ksi	MPa	ksi	MPa	2" (50.80mm)	Rockwell	B
20Cb-3	N08020	100	689	50	345	40		85
439		70	483	50	345	30		81
216		100	689	55	379	45		90
410S		60	415	30	207	22		88
18-2 FM*	S18200	70	483	48	331	30		87
18-2	S44400	60	415	45	310	20		95
26-1		60	415	35	241	20		
26-1 Ti		68	469	45	310	20		
18-18-2		75	517	30	207	40		96
A286	K66286	145	1000	95	655	24		
6X		93	641	45	310	46		80
Nitronic 50		128	886	86	595	36.5		C21
29-4		90	621	75	517	25		95
29-4-2		95	655	85	586	22		97
18-18-Plus*		120	827	69	476	65		95

\*Bar Properties

\*( ) references, page 56

Figure 12

## Catalytic Reforming

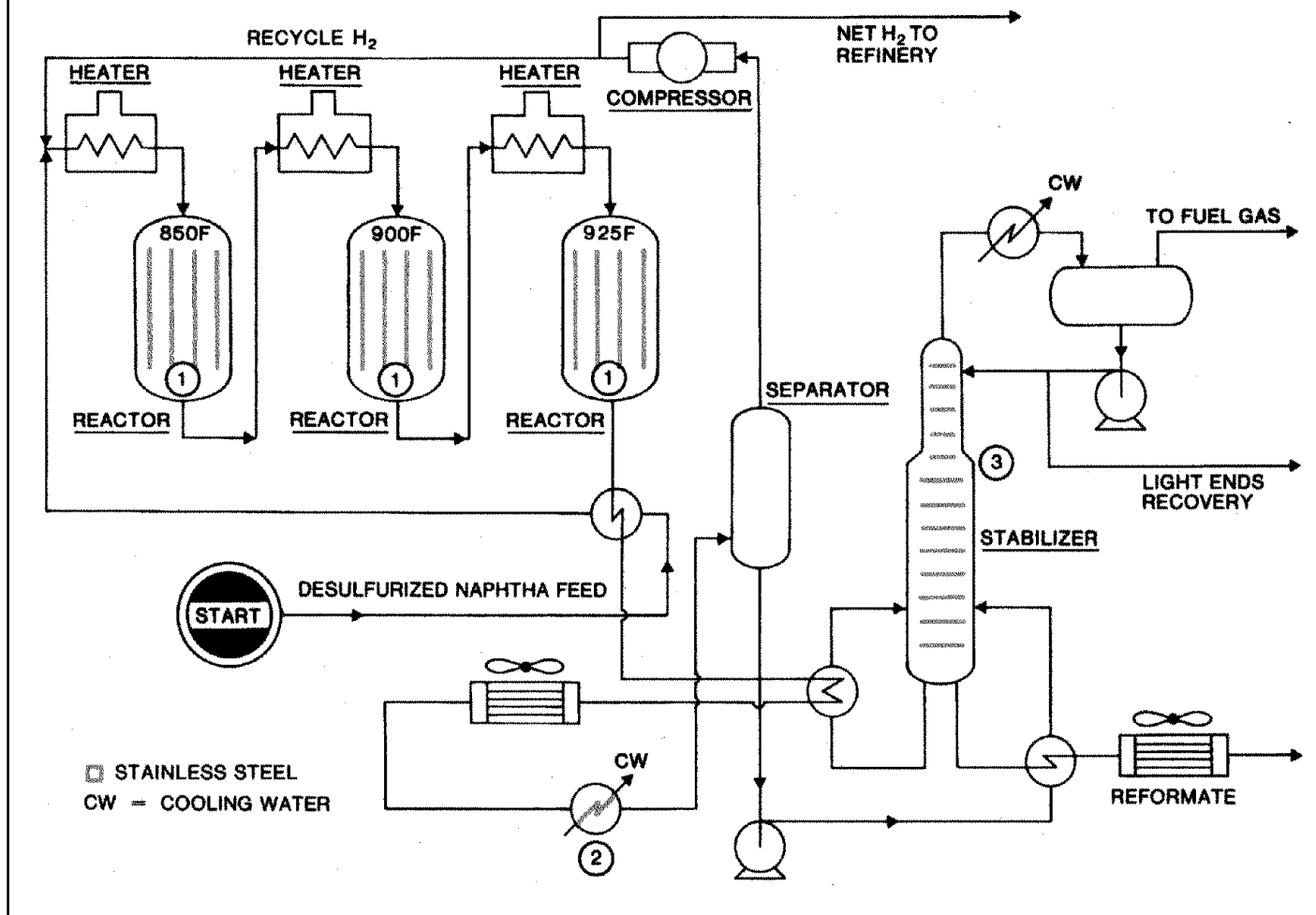

### Catalytic Reforming

Catalytic reforming (Figure 12) increases the antiknock quality of motor fuel blending stocks. The principal reaction in this process is dehydrogenation of naphthenes to form aromatics. As a result, hydrogen is produced, some of which is recycled to sustain reformer reactor pressure and to reduce coke formation. Most of the hydrogen is available for hydrotreating, hydrocracking, and other processes.

Feed stock for catalytic reforming is naphtha, which has been desulfurized. If the sulfur compounds are not removed, they would poison the noble catalyst.

Because sulfur is removed, the stream is not very corrosive, and carbon or low-chromium steels are adequate for most applications – except possibly in the final reformate cooler. Also, reactor internals, point 1, such as shrouds, thermowells, catalyst support devices and screens, are usually Type 304. In this latter case, the need is for high-temperature strength.

There are two potential corrosion problems in the final reformate cooler, point 2: one from the cooling water and the other due to the use of organic chloride to regenerate the catalyst. The organic chloride is added to the stream continuously to keep the catalyst active.

When the stream gets to the final cooler, the temperature is reduced to the point at which ammonium chloride can precipitate, and if water is present, this can be very corrosive to steel and brass. Moist ammonium chloride will cause pitting of Types 304 and 316.

Consequently, if stainless steel is picked for this component: it must be adequate to resist pitting on the cooling water side. Stainless alloys best suited for the final reformate cooler are 329, 6X, or 29-4.

The use of Type 304 trays, downcomers and beams in the stabilizer (point 3) would greatly reduce iron corrosion-product tray fouling.

**Figure 13**  
**Hydrocracking**

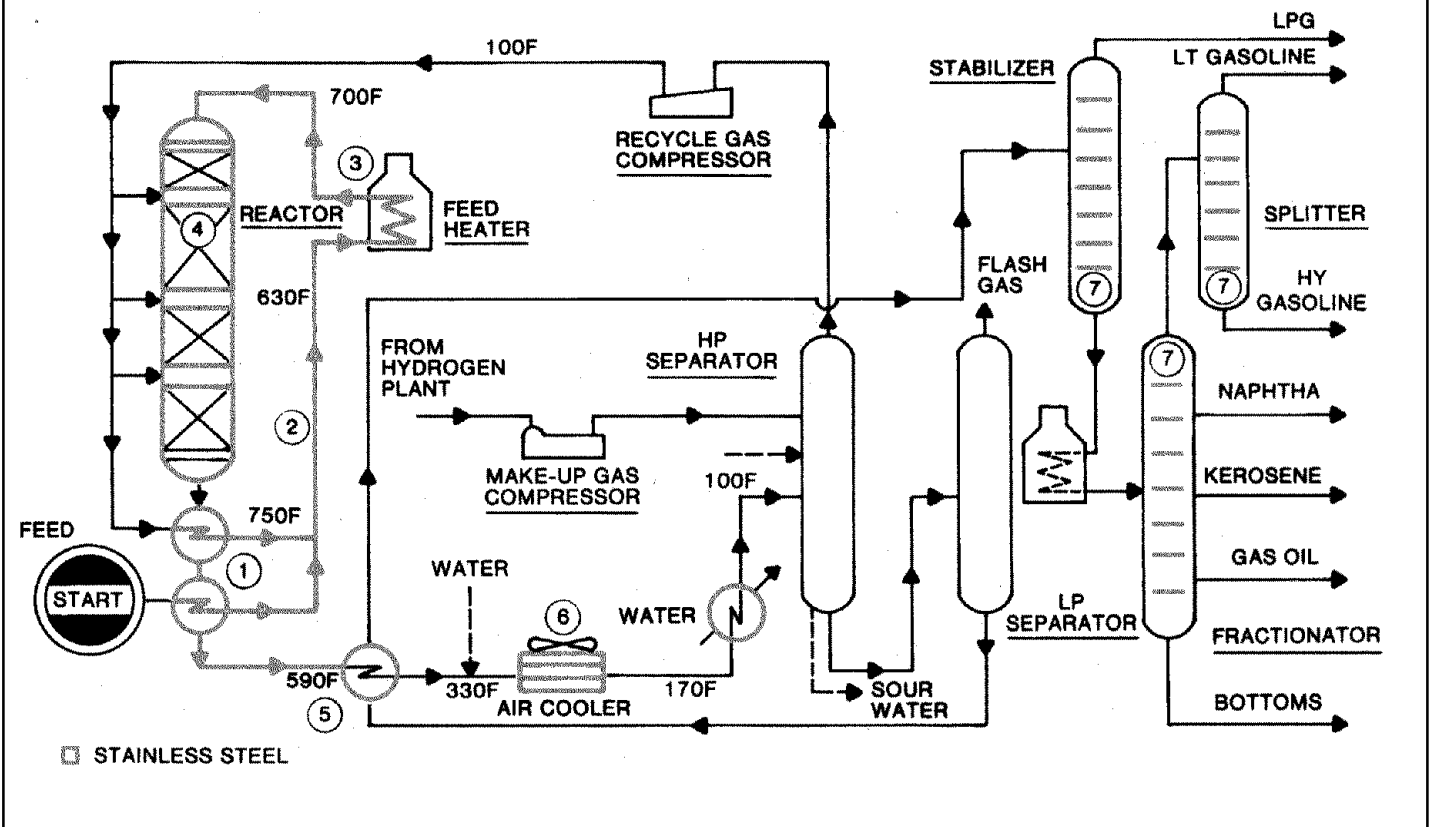

## Hydrocracking

Hydrocracking is, in essence, a combined desulfurization and cracking operation that can convert a full range of hydrocarbon feedstocks into more valuable products. The conversions occur in the presence of high-pressure hydrogen; hence hydrocracking is hydrogenation or addition of hydrogen to molecules. The diagram in Figure 13 represents one specific process. However, differences do occur from plant to plant, particularly in the number of reactors and arrangement of heat exchangers. Most systems have more than one reactor, with large plants having a desulfurizing reactor first, followed by a hydrocracking reactor.

The reactions take place at temperatures of 650-850F (343-455C), at pressures anywhere from 1200 to 3000

psi (8.2-20.7 MPa), and in the presence of a hydrogen-rich recycle gas stream. After heat exchange with the hot effluent, the charge oil and recycle gas streams are combined and heated in a feed heater to the desired inlet temperature. To control the temperature of the highly exothermic reactions, cool recycled "quench" gas is injected between beds in the reactor. The reactor effluent is cooled, then flashed and washed in the high-pressure separator, flashed at low pressure and fractionated.

The corrosion problem considerations and compensatory remedies are quite similar to those in hydrotreating.

The stainless steels used in hydrocracking desulfurizing reaction section are Types 304, 321, 347, 410 and 430. The austenitics are preferred because of their better high-temperature strength, and because of potential

problems of 885F embrittlement with ferritic stainless steels. However, ferritic stainless steels, Type 430 and 26-1 have been used as the tube material for feed-effluent exchangers operating below 700F (377C). The newer grade 18-2 would be satisfactory in the same locations.

The stabilized grades are used to prevent sensitization – especially in welds – and the possibility of polythionic stress-corrosion cracking.

With the feed and recycle gas flowing through heat exchangers, point 1, it is safe to assume that the stream temperature will be above 550F (288C) and the use of stainless steel is justified. The reactor effluent on the opposite side is certainly above 650F (343C), so regardless of what materials are used on the feedside, the effluent requires stainless. Type 304 tubing has been

used, but Types 321 and 347 are preferred because of lower susceptibility to polythionic stress-corrosion cracking. In some plants, 430, 410, 26-1 and 330 are being used in the feed effluent exchangers.

The tube sheets for feed-effluent exchangers are made from Types 347, 321 or 304 solid, clad or weld overlay, as the case may be. The channel section also is made of the same alloys. The shell is usually clad with stainless steel to be resistant to sulfidation from the hot effluent stream.

Feed piping, point 2, once the temperature reaches 550F (288C), normally is stainless. It depends on plant size whether or not the most economical pipe is wrought austenitic stainless or centrifugally cast HF modified. In the modification there is usually lower carbon and controlled ferrite, which provides somewhat more resistance to polythionic cracking. The wrought alloys most commonly selected for piping are Types 347 and 321. Types 304 and 330 have also been used.

In the feed heater, point 3, Types 304, 347 or 321 furnace tubes have been used, even though they may be aluminized to minimize scaling.

Some operating companies aluminize stainless steels for added protection against polythionic attack possibilities and to minimize high-temperature sulfide scale formation. This approach is used by these companies for hydrotreaters and for the desulfurization stage in hydrocracking. These companies prefer to aluminize an alloy which is corrosion resistant by itself, in the event that the aluminizing is incomplete or eventually is consumed by high-temperature corrosion.

The reactor shell, point 4, generally is not stainless although it will be clad or weld overlaid with Type 347. Some installations have used Type 309 as a weld overlay with the final cover being Type 308, which contains ferrite and resists cracking. Nozzles will also be clad or weld overlaid. Bed supports, distributor trays, catalyst screens, thermowells and thermowell sheaths, and gasketing are usually all stainless, either Type 347, 321, 304 or 309 or 310.

The third feed-effluent exchanger, point 5, is used as a stabilizer feed heater. Since stabilizer feed is sour (hydrogen sulfide has not been removed

at this point in the process), the heat from the effluent which contains hydrogen sulfide may be sufficiently high to cause sulfidation of low-alloy tubing on both sides. The need for a sulfidation resistant alloy has been required in some plants. Stainless steels such as Types 430, 410 and 304 are being used. However, there is a danger of chloride cracking from inadvertent carry-through of separator water, so Types 304, 347 and 321 may not be as advisable as a ferritic grade, or Types 329 or 330.

The air cooler, indicated by point 6, has typically been built of carbon steel. However, many plants processing sulfur/high-nitrogen stocks have encountered an erosion-corrosion phenomenon from ammonium hydrosulfide at high-velocity areas and points of turbulence such as tube inlets. (5) (6) (7) The remedy has been to employ Type 330 for tube and header boxes. Types 410 and 430 have not been sufficiently corrosion resistant to this form of aqueous corrosion.

Figure 13 is typical of a single-stage hydrocracker. Some hydrocracking processes involve a desulfurizing stage and a hydrocracking stage. In the second stage, one licensed process retains some sulfides to aid the special

catalyst in its cracking function. The second stage requires corrosion resistant alloys discussed above. Another competitive licensed process hydrocracks in the absence of hydrogen sulfide. In this case, stainless alloy requirements are greatly reduced.

Other applications for stainless may be for internal parts in the stabilizer and fractionator, point 7, valve stems, valve trim and pump shafting.

There are some problems with stainless, particularly scaling on close-fitting parts, such as valves. Any minor scaling on these parts makes them inoperable. Types 410, 416 and 440 are sometimes found not to be sufficiently corrosion resistant and to form just enough tenacious scale to cause binding of working parts. Precipitation hardening stainless steels in combination with Types 304, 309, 310 or 330, or select proprietary grades, provide the corrosion resistance needed.

**Figure 15**

*Carbon steel is very actively corroded by strong carbonic acid, such as occurring in hydrogen plants. Stainless steels with 12% or more chromium are very resistant to carbonic acid attack.*



Figure 14  
Hydrogen Plant

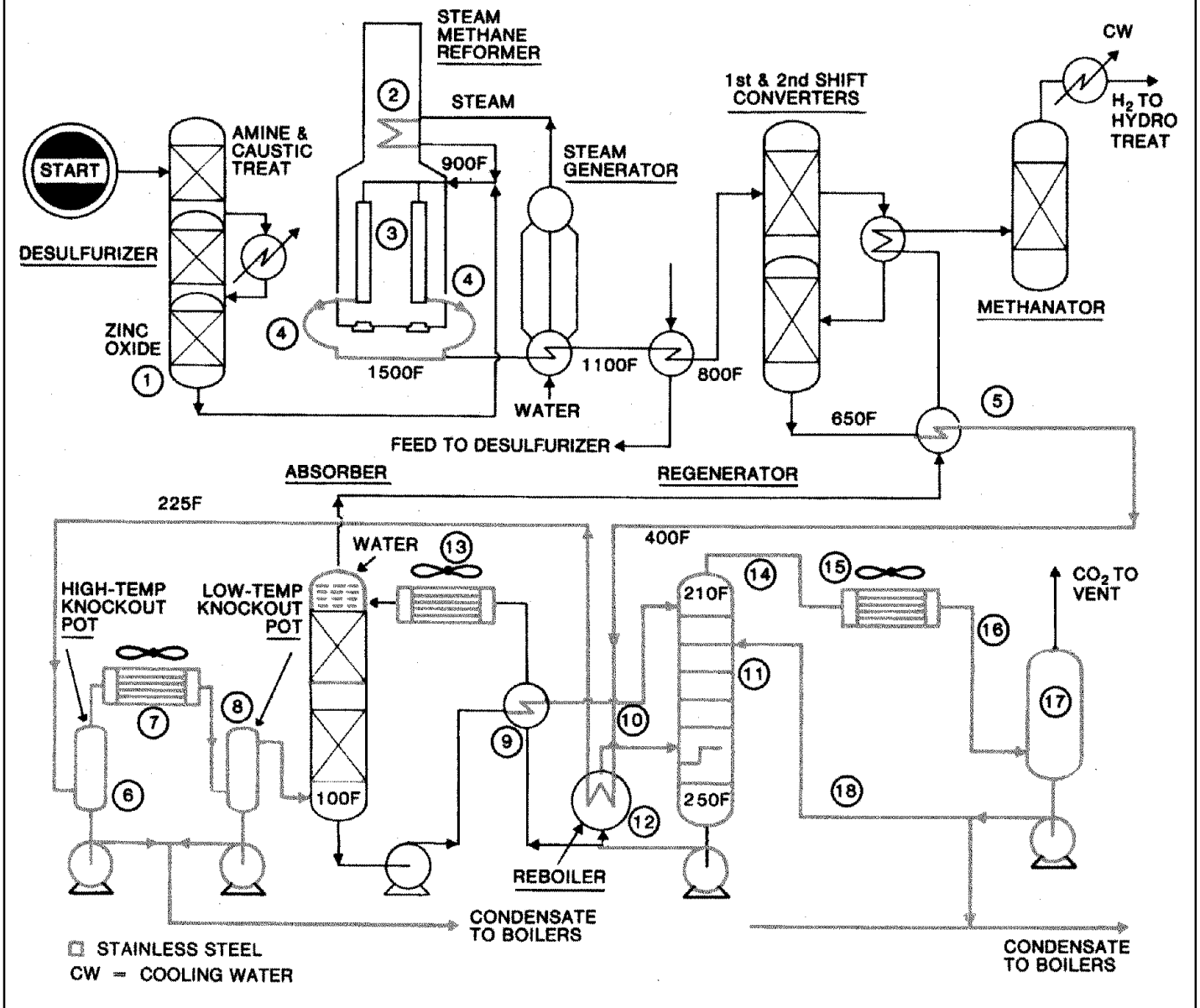

### Hydrogen Production

Hydrogen for hydrotreating and hydrocracking in a large modern refinery is produced by the classic “water gas” reaction of steam with carbon (gas in a refinery) at high temperature over a catalyst. Refinery steam methane reformers use a nickel base catalyst in externally fired vertical tubular reactors in a fire box enclosure or furnace (Figure 14). The steam and methane reform into

hydrogen, carbon monoxide and carbon dioxide. The hot, 1500F (816C), effluent is cooled in a waste-heat boiler and feed pre-heaters and then enters two stages of shift conversion over an iron oxide catalyst. The carbon monoxide is converted to carbon dioxide and hydrogen.

The shift gas is cooled and then contacted with a solvent such as potassium carbonate,

monoethanolamine (MEA), sulfinol, etc. to remove the carbon dioxide. The solvent is regenerated.

The semi-pure hydrogen is methanated over a nickel base catalyst to convert traces of carbon monoxide and carbon dioxide to methane. The gas is cooled, compressed and delivered to refinery processes needing hydrogen.

The temperatures for metal application vary from room temperature to a 1750F

(943C) tube skin temperature in the reformer. Pressures range up to 400 psi (2.8 MPa).

The stainless steels used most frequently in hydrogen plants are Types 304, 304L, 310, 330, 410, 430 and cast grade ACI HK-40. The environments of principal concern for stainless use are high temperature, high velocity, steam, steam condensates very rich in carbon dioxide (carbonic acid) and the need to keep steam condensate free of iron contamination.

Since the nickel catalyst is poisoned by sulfur, the feed is desulfurized in various ways including combinations of activated carbon, amine scrubbing, caustic scrubbing, and catalytic desulfurization, followed by zinc oxide absorption. Since a great deal of stainless is utilized and is necessary, steam and process water must be kept pure for process reasons and free of chloride to avoid stress-corrosion cracking. Upsets have occurred where chlorides (leached from activated carbon, MEA, and potassium carbonate) and caustics have entered the system and caused cracking and corrosion until removed.

Carbon steel is very actively corroded by strong carbonic acid (Figure 15). Chromium additions to steel reduce the rate of attack. Steels that contain 12% chromium or higher are found to be extremely resistant to carbonic acid for use in cooled shift gas, carbon dioxide absorption and in solvent regeneration.

Figure 14 shows first the desulfurizing equipment at point 1. In this step, little stainless is required or seldom used. Point 2 is the steam superheater prior to reforming. The hottest superheater tubes, achieving temperatures of 1300-1350F (704-733C), require Type 304 or 330 seamless or welded tubing for adequate oxidation resistance and creep-rupture strength.

The vertical reformer, catalyst-filled tubing, point 3, with skin temperature from 1300F (704C) at the top to 1750F (954C) at the bottom, are predominately ACI HK-40. Several of the early version low-pressure reformers used Alloy 800, which is similar to Type 330 stainless steel.

The hot reformed gas issuing from each vertical tube is connected to a sub-header, about 6"-8" in diameter, by short lengths of 1½" diameter piping

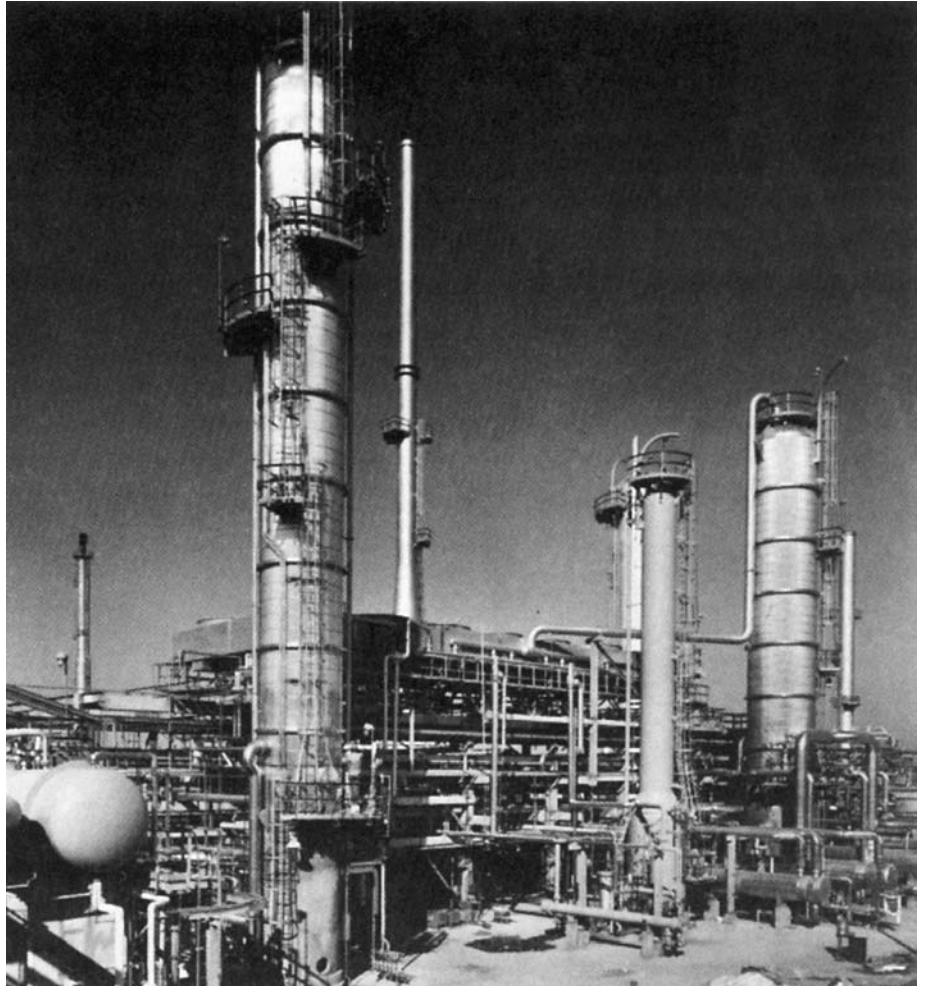

*Amine and sour water treating facilities at the Marathon Oil Company Garyville Refinery. Sulfur recovery and tail gas units remove more than 240 LTID of sulfur from refinery waste gases.*

*Photograph: Marathon Oil Company Ralph M. Parsons Company*



*A typical stainless steel valve cap tray that might be used in a fluid catalytic cracker gas treating plant.*

*Photograph: Glitsch, Inc.*



called "pigtailed", point 4. The pigtailed and sub-headers containing 1500F (816C) reformed gas are made of Type 330 or Alloy 800. Most sub-headers are connected to refractory-lined steel main headers, and to piping to the waste-heat steam generator. The refractory is most satisfactory if it is protected and held in place by a thin-walled internal shroud of Type 304 or 310 stainless steel. Refractory anchors or clips are made from Type 304 rod or strip.

From the steam generator through feed-versus-reformer-effluent exchangers and through the shift converters, there is no requirement for stainless steel. But when the shift gas is loaded with carbon dioxide, and steam drops in temperature below the dew point, a corrosion resistant alloy is required. Type 304 is the common choice although 430, 410, 18-2, 26-1 or any stainless steel would be satisfactory. On Figure 14, point 5, both the exchanger and shift gas piping, through the solvent reboiler to the knockout pots, points 6 and 8, and the intermediate air cooler, point 7, are typically all built of Type 304. If carbon steel was used in these locations, as experience has shown,

*A 40' diameter (12.2m), two-pass ballast tray with Type 304 mesh pad mist eliminator is being assembled for a vacuum tower.*

*Photograph: Glitsch, Inc.*

corrosion to the point of penetration would result in some locations within one year.

When the shift gas contacts the carbon dioxide removal solvent, such as MEA or potassium carbonate, the carbon dioxide is captured and inhibited as long as it is held in solution. The absorber can be built of steel although screens for packing support might be Type 304. In the upper portion of the absorber, condensate is injected onto several wash trays to remove traces of the solvent, thus to prevent carryover into the methanator. The trays and tower shell in this area should be Type 304.

The loaded solvent is non-corrosive except when heat and turbulence separate the carbon dioxide temporarily from its loose chemical bond with the solvent, forming hotwet corrosive carbon dioxide or carbonic acid.

As the loaded solvent is heated at point 9, conducted to the regenerator, 11, in stainless piping shown at point 10, reboiled at point 12, and stripped in the regenerator, point 11, the action is so violent and turbulent as to free carbon dioxide temporarily. Stainless steel is indicated at these locations. Pumps invariably have to be built of cast stainless steel, CF-8, with Type 304 or 416 shafting. The lean solvent retains some carbon dioxide. The lean solvent cooler, shown at point 13, frequently

requires Type 304 because of turbulence at tube inlets and in the header boxes. Wet carbon dioxide is taken overhead through stainless piping at point 14, to an all-stainless air cooler or water-cooled condenser, point 15, with 304 piping conducting the condensate, 16, to the receiver, 17. Type 304 is the most popular choice for all of this equipment. The condensate, at point 17 (a reflux drum) is laden with carbon dioxide so Type 304 is required. Not only the drum, but also the drain line, pump and reflux line at point 18 are normally built of Type 304.

There are conflicting reports as to whether Type 304 or 304L should be used for piping and tower linings where fusion welding is required and carbide precipitation will occur. Both Types 304 and 304L have been used in welded equipment, and both grades can be found serving very reliably. If there is any doubt about intergranular corrosion in a particular plant, corrosion testing of sensitized specimens might be the best course of action.

If the purified hydrogen is relatively free of moisture and carbon dioxide, there is no need for stainless steel piping, beyond the absorber or beyond an overhead knockout pot (not shown on the diagram). The gas to the methanator preheater, the methanator, and to refinery hydrotreat is non-corrosive.

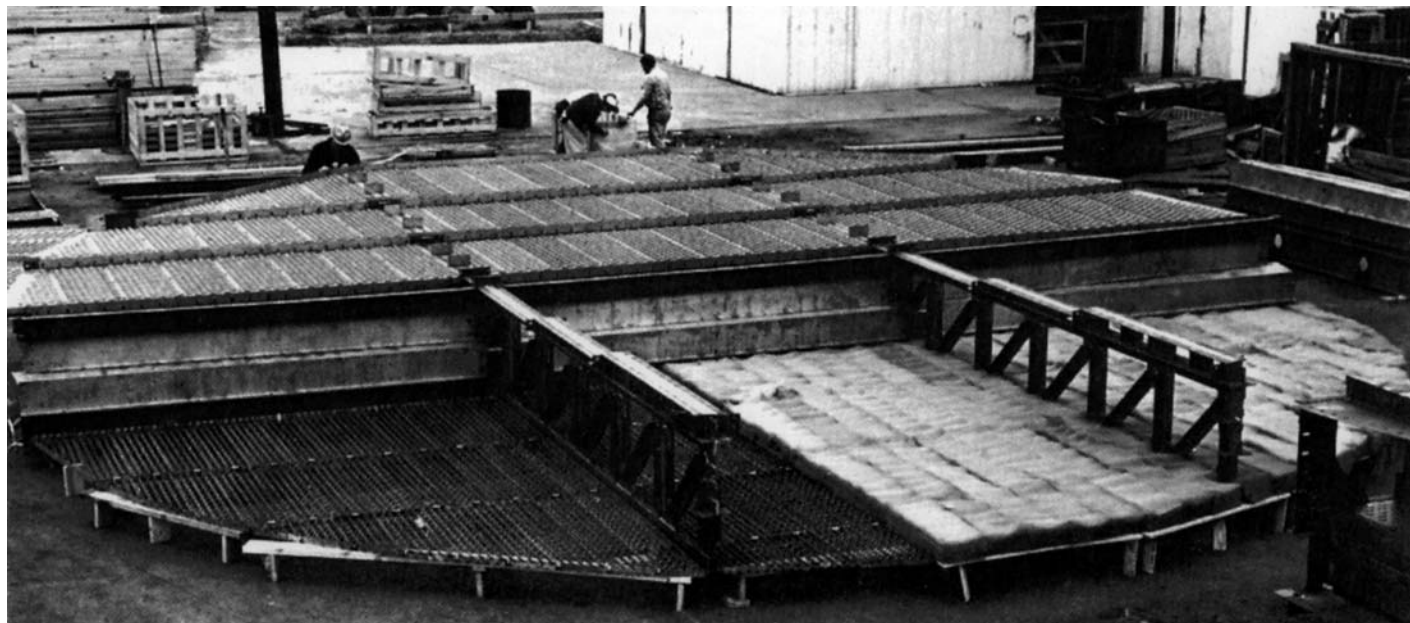
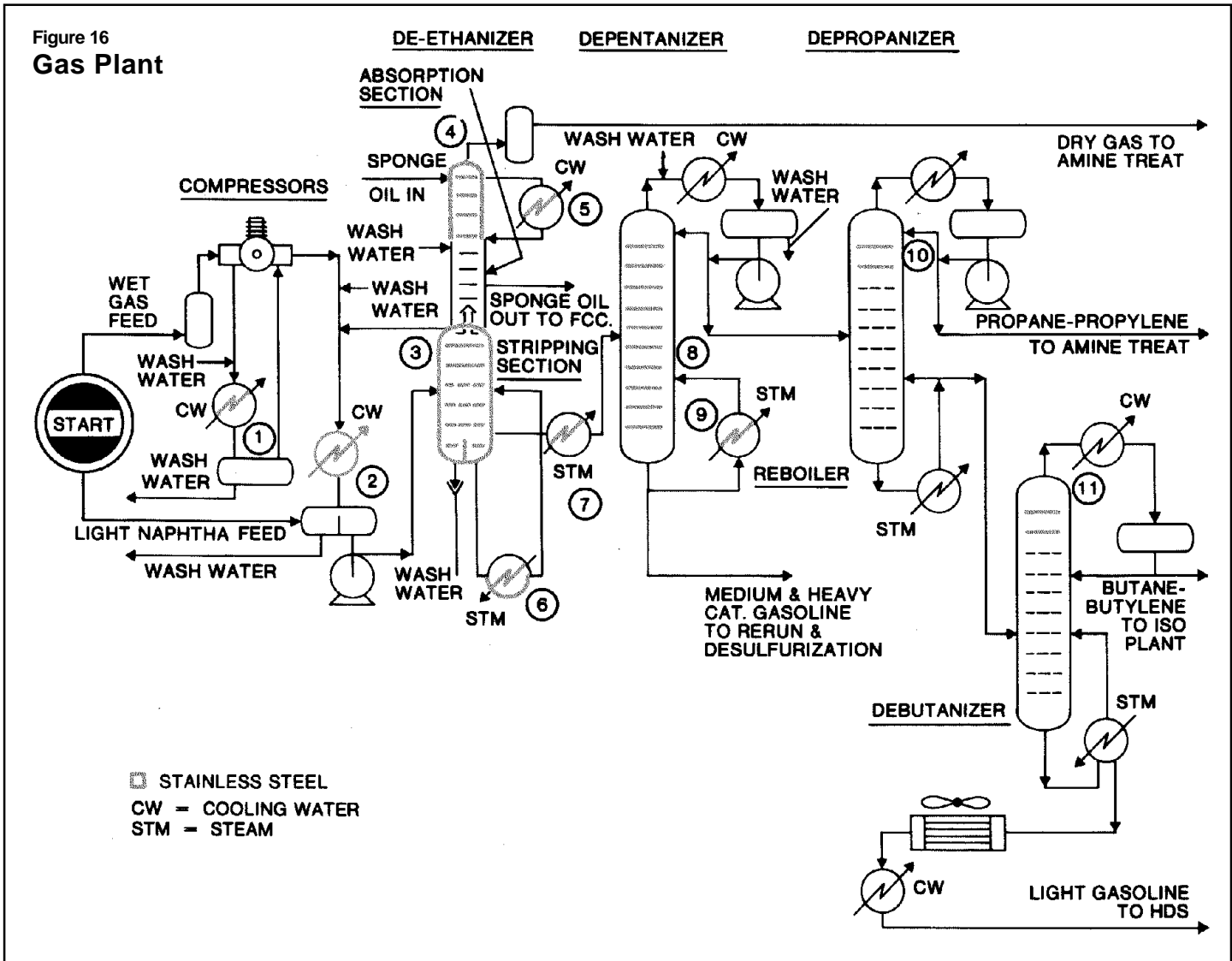

Figure 16  
Gas Plant



## Gas Plant

Figure 16 shows the flow diagram of a gas plant associated with a fluid catalytic cracking plant. Gas plants stabilize naphthas by separating lighter, valuable fractions for gasoline blending, for sale as domestic and industrial LPG gases, for petrochemical feed stocks, or for refinery fuel gas. The light and heavy naphthas are desulfurized and reformed.

A gas plant often has a fractionation phase called rerun or fractionation. Figure 16 omits this portion, since it usually is not too corrosive, and carbon steel is the predominant material of construction.

Gas plants are built largely of carbon steel. However, there are components

and areas where corrosion of steel is too high and a stainless steel is more economical. Most of the positions are indicated by numbers in Figure 16.

The corrodents in cat cracker naphtha and wet gas are: hydrogen sulfide, ammonia, hydrogen cyanide, water and chloride. Refineries running crudes with substantial nitrogen, will generate hydrogen cyanide in the cracker. Cyanide, at certain pH values, will activate the steel surfaces (8) and increase the amount of atomic hydrogen entering steel walls, pipe, etc. This frequently results in hydrogen blistering of laminated steel plate and sulfide cracking of hard welds.

Hence, as shown in Figure 16, the use

of liberal waterwash with inhibitors, such as ammonium polysulfide, dilutes the cyanide and converts it to less troublesome thiocyanates. Austenitic stainless steels, owing to their very low corrosion rates, and their lack of damage by hydrogen sulfide, make good liner materials for columns, and they provide long life for trays. The stripping section of the de-ethanizer is an area where blistering frequently occurs. That is why Type 316 is used for the lining and internals.

Stainless steels are also used for resistance to general or uniform corrosion by acidic wet sulfur compounds, ammonium chloride and from cyanide not reacted with inhibitor.

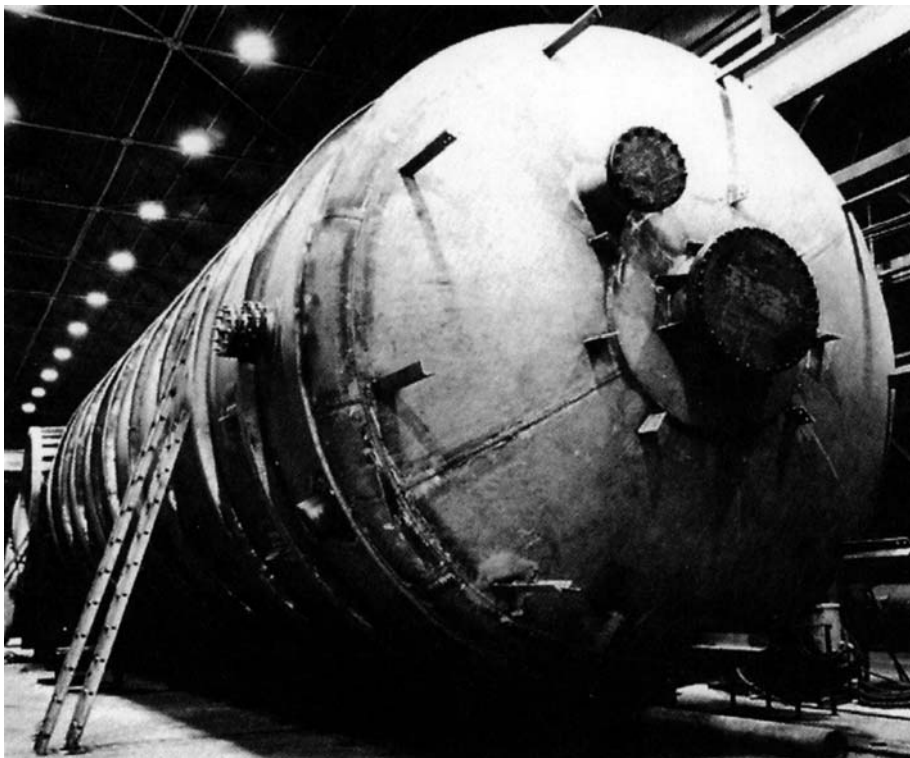

Process reactors in a petroleum refinery can either be solid stainless steel (above), clad, or protected with a weld overlay (below), such as might be used in an HDS reactor.  
 Photographs: Wyatt Industries, Inc.



Commonly used are Types 304, 304L, 316, 316L, 329, 410, 405 and 330. In the future, 26-1, 6X, Nitronic 50, 29-4-2 should find occasional applications,

particularly when cyanides are causing serious corrosion.

Points 1 and 2 are compressor inter-coolers and after-coolers. Tubing

and shells are frequently seriously corroded. Stainless steels 304, 316, 329 and 26-1 have all been used in this service depending on severity. In extremely serious situations titanium is chosen. However, some corrosion engineers feel that the relatively new stainless steels, 6X or 29-4 should perform as well as titanium in this service. (This comment also applies to alloy selection for components indicated at point 5). The stripping section, 3, of the de-ethanizer is frequently reported to suffer hydrogen blistering from wet hydrogen sulfide. Either 304 or 316 is selected to clad or line the shell and for tray components.

Location 4 in the upper portion of de-ethanizers is frequently corroded by condensation of water droplets, ammonium chloride, ammonium sulfide, and cyanide. Type 304 is the most common choice for lining and tower internals.

Reboilers are low points in a fractionation system which tend to trap and collect scale and other solids, to drop out water of absorption upon heating, and to collect entrained water. Carbon steel tubing frequently has short life. The de-ethanizer and the depentanizer reboilers, points 6 and 9, are subject to corrosion and pitting from hot corrosive water trapped in sludge both on the shell and tubes. The lower quadrant of reboiler shells are frequently lined with Type 316, while tubing is replaced with 329, 330, 20Cb-3, or more-corrosion resistant alloys. Corrosion of reboiler tubing poses a difficult problem because conditions exist for general corrosion, pitting and chloride stress-corrosion cracking of susceptible austenitic alloys. Highly corrosion resistant austenitic and ferritic grades should be considered, such as 6X, Nitronic 50, 29-4, and 29-4-2.

Point 7, the depentanizer preheater has shown corrosion from wet feed so crack resistant and corrosion resistant 329, 330 and 26-1 have been selected for this service.

Depentanizer columns, point 8, have been reported to require Type 410, 304, or 316 internals to realize economical life.

Refiners also point out the value of Type 410 tray components in the top portions of the depropanizer and debutanizer, points 10 and 11.

Figure 17  
**Gas Treating**  
**Amine Treating**

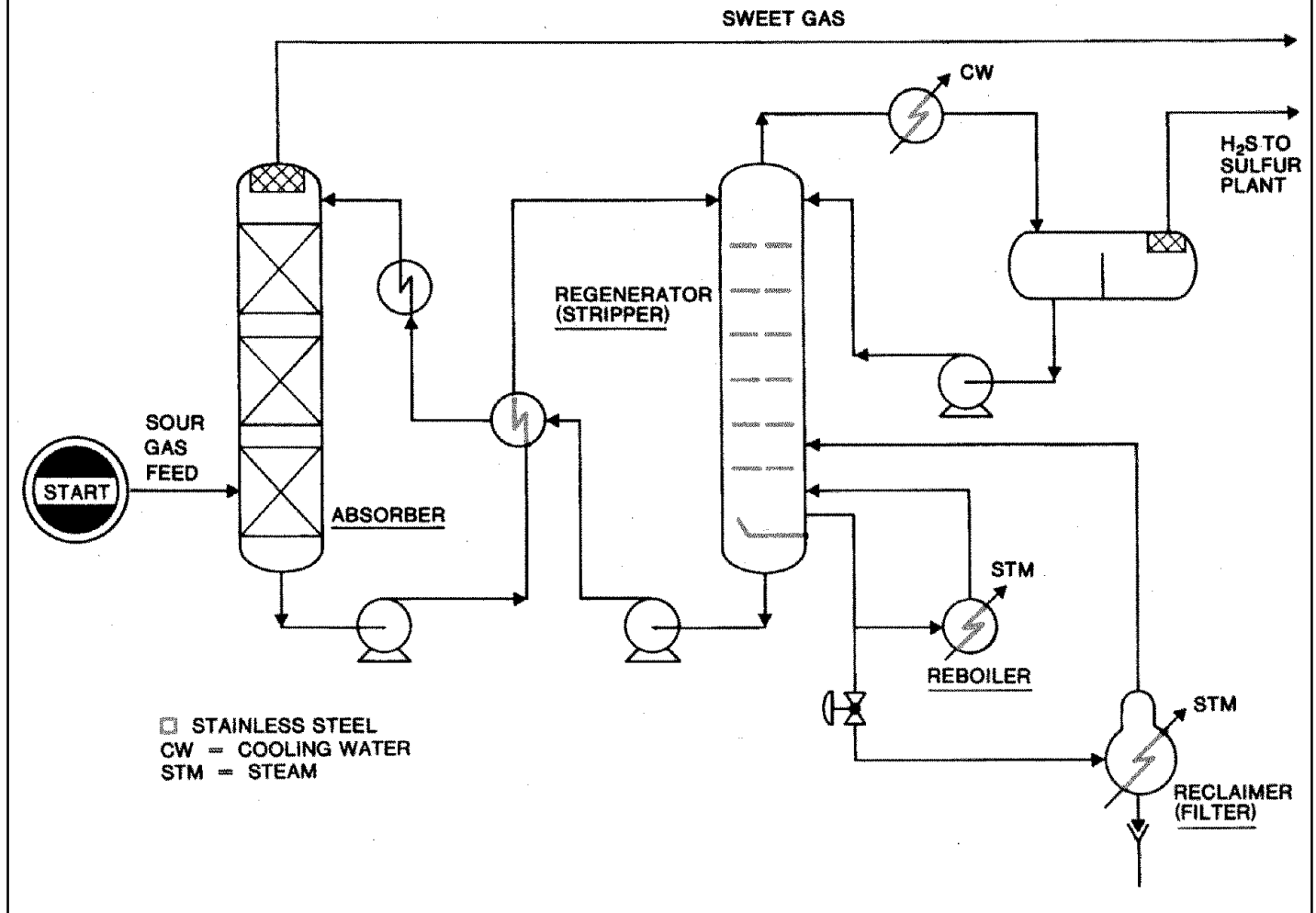

### Amine Plant

An amine system removes hydrogen sulfide and carbon dioxide from various fuel gases produced in a refinery so as to prevent air pollution when the gases are burned. The basic operation is absorption in which the gas is contacted with a solvent that preferentially dissolves the undesirable constituents. The most common solvents are diethanolamine (DEA), which is used when the gas contains only hydrogen sulfide, and MEA, which removes both hydrogen sulfide and carbon dioxide – such as with fuel gas from a fluid catalytic cracker.

Amine plants consist basically of two

units, Figure 17; the absorber in which the unwanted gas constituent is removed, and a regenerator in which the solvent solution is reactivated. In the absorber, gas flows up through the column and the amine cascades down, providing intimate contact. Sweet gas exits the top, and rich amine leaves through the bottom.

In the regenerator, the hydrogen sulfide and carbon dioxide are driven off by heat and stripping steam. The lean amine solution is returned to the absorber.

In new plants, the rich/lean exchanger train is often constructed initially of carbon steel. The corrosion problem depends largely on the concentration of

hydrogen sulfide. As with most plants, there is a tendency to build the unit too small, and, as it gets older, its capacity is increased. Thus, the hydrogen sulfide content of the rich amine solution increases and the corrosion problems get worse. The original carbon steel is then frequently replaced with stainless, beginning with Type 410 and then increasing to Types 430 and 304.

The regenerator reboiler usually requires stainless, either Type 430 or 304, because of the higher temperatures involved.

DEA is reconstituted using a pre-coat filter and treating heat-stable salts of DEA with soda ash. The filter elements are constructed of Type 304.

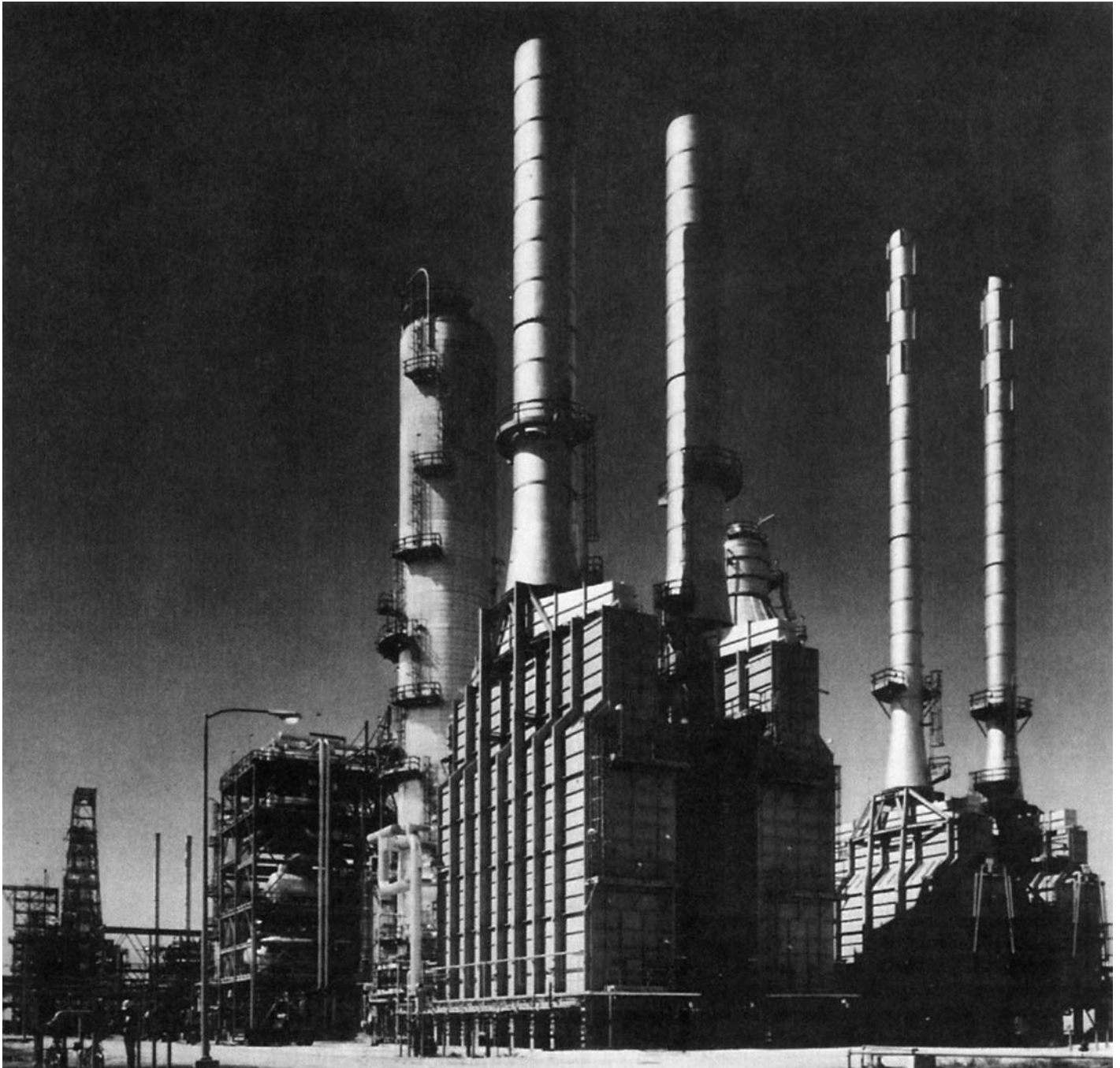

*Crude unit heaters of Marathon Oil Company 200,000 barrels-per-day (BPD) Garyville Refinery in Louisiana. Photographs of the refinery appearing in this booklet were supplied by Marathon Oil Company and Ralph M. Parsons Company, the prime contractor.*

MEA is reconstituted via a reclaimer which is in essence a miniature reboiler for driving off only steam and MEA vapor. Left behind for occasional blowdown or

washing out are the heat-stable salts or polymerization products of MEA. Reclaimer service is severe on metals. Reclaimer tubing is usually 316, 329, or 20Cb-3.

In MEA plants, the corrosion problems appear to be more severe than in DEA plants. While carbon steel might be used in MEA, it is more likely that modern units will start with stainless steel in the rich/lean exchanger train and in

reboilers.

In MEA plants removing *only* carbon dioxide, more-severe corrosion problems can be expected. This is due largely to the fact that carbon dioxide is a stronger acid than hydrogen sulfide.

When other solvents are used, such as Catacarb and Sulfinol, consideration should be given to using Type 304 for the rich/lean exchangers, reboiler, and the overhead gas cooler.

Figure 18  
Sulfuric Acid Alkylation

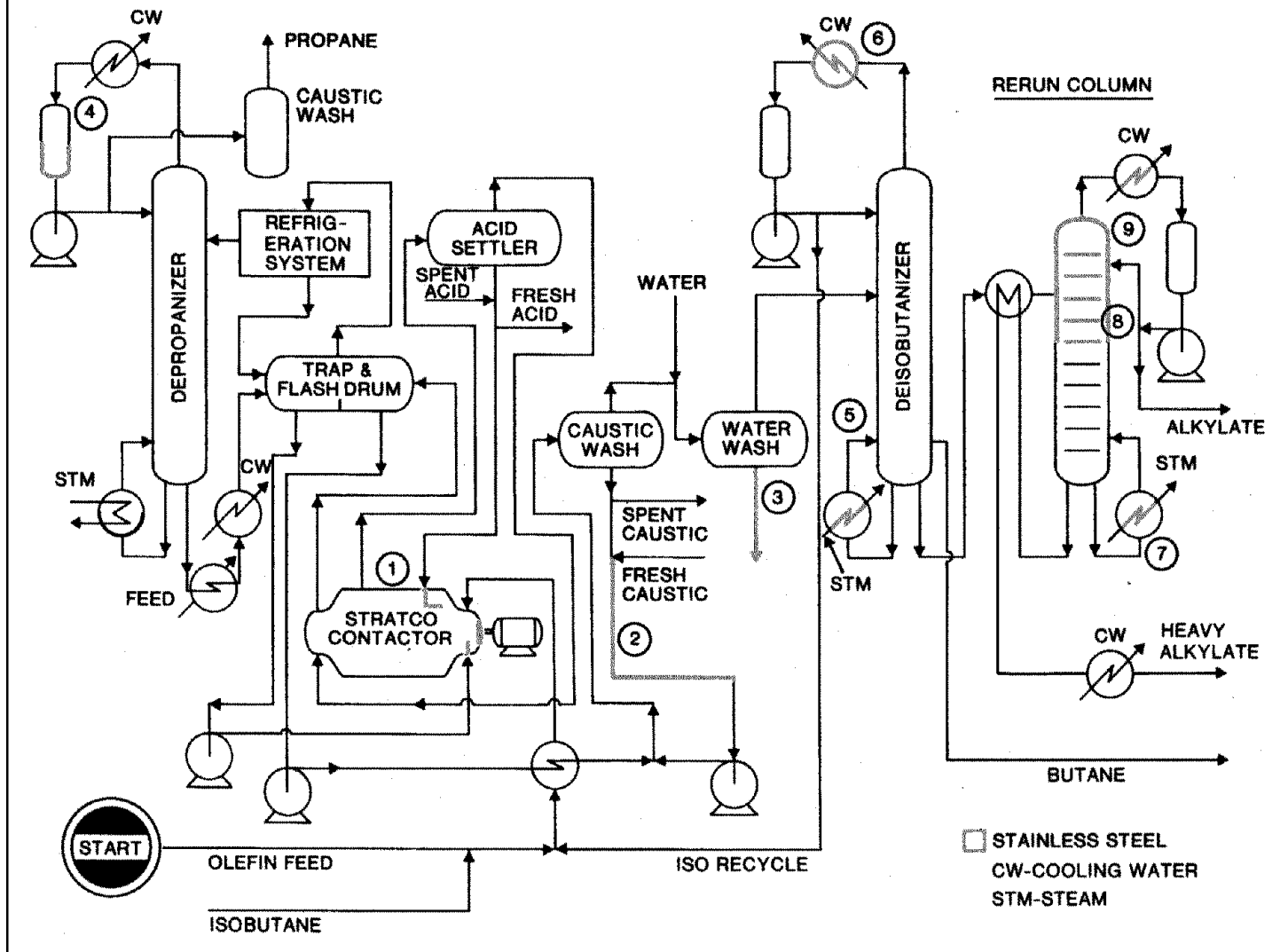

### Sulfuric Acid Alkylation

Alkylation is defined broadly as combining an olefin with an aromatic or paraffinic hydrocarbon using a catalyst. The two catalysts used are sulfuric acid in both the Stratco System and the Cascade (Kellogg) Process, and hydrofluoric acid in another process not discussed here.

Feeds to sulfuric acid alkylation commonly consist of isobutane and C<sub>3</sub>-C<sub>5</sub> olefins such as butene resulting in a 2,2 dimethyl hexane product. The product is a particularly desirable constituent of automotive and aviation

gasolines for increasing the octane rating.

A simplified flow diagram is shown in Figure 18 of a process employing the Stratco technology. Simply stated, the hydrocarbons, isobutanes and olefins are mixed, cooled and contacted at low temperature with 98% sulfuric acid in a patented contactor. The intimately mixed and reacted product is settled and separated, since acid is not soluble in hydrocarbon. The alkylate and hydrocarbon product is caustic washed and water washed to remove traces of acid and acid hydrocarbon byproducts.

The hydrocarbon is then successively fractionated to separate propane, isobutane, butane and rerun to separate two grades of alkylate. It is to be noted that there is a propane recycle from the depropanizer which functions as the chilling medium (refrigerant) in the process.

Alkylation plants are built basically of carbon steel, but sulfuric acid-resistant alloys are required in some areas. The alloys are primarily 316, 316L, 20Cb-3, and nickel-base alloys. Although carbon steel is resistant to concentrated sulfuric acid in the strength range of 90%-98%

found in alkylation, steel loses resistance under high velocity conditions (3'/sec) and above 100F (38C).

Downstream of the water wash system, traces of acid and water in corrosive dilute concentration occurs from entrainment or carryover. Also, sulfate-hydrocarbon compounds are formed in the reaction which break down with heat, liberating sulfur dioxide.

Spent alkylation acid contains an appreciable concentration of entrained light hydrocarbon which must be removed by flashing, which is corrosive to steel, or by a slow weathering process. Alloy 20Cb-3 is frequently used in the flash equipment (not shown in the diagram) for heat exchanger tubing, flasher overhead piping, and lining and internals of the flashdrum.

In Figure 19 are isocorrosion curves for 20Cb-3, 316 and carbon steel in sulfuric acid. The bottom diagram, for example, shows carbon steel to have a corrosion rate of less than five mils per year in 98% acid at ambient temperature. At 90% concentration, the corrosion rate is sufficiently low, which does not justify the use of alloy materials. However, if acid dilution is anticipated, which will cause a rise in temperature, carbon steel is not effective because corrosion rates increase rapidly over 100F (38C).

The diagram for Type 316, on the other hand, shows a low corrosion rate in 90% acid up to 100F (38C). This is also true for acid concentrations of less than 10%.

Alloy 20Cb-3 is much better, however, for a wide range of acid strengths at temperatures over 100F (38C).

Stratford Engineering Corporation uses 20Cb-3 for feed piping and at points of turbulence in the contactor, point 1.

At point 2, in the caustic wash system, the heat of dilution and reaction with caustic requires 20Cb-3 or even Teflon® lined 20Cb-3. Occasionally, the wash water from the water-wash vessel, point 3, is found to contain enough acid to be corrosive. This area could be a candidate for Type 316, or 316L if the piping requires welding.

The overhead accumulator, point 4, has been reported to suffer corrosion from an acid sludge buildup in the lower section. Type 316L or 20Cb-3 has been used for strip lining. As the temperature is successively elevated in the deisobutanizer, the debutanizer if one is employed, and the rerun column used in

Figure 19 Corrosion Rates In Sulfuric Acid

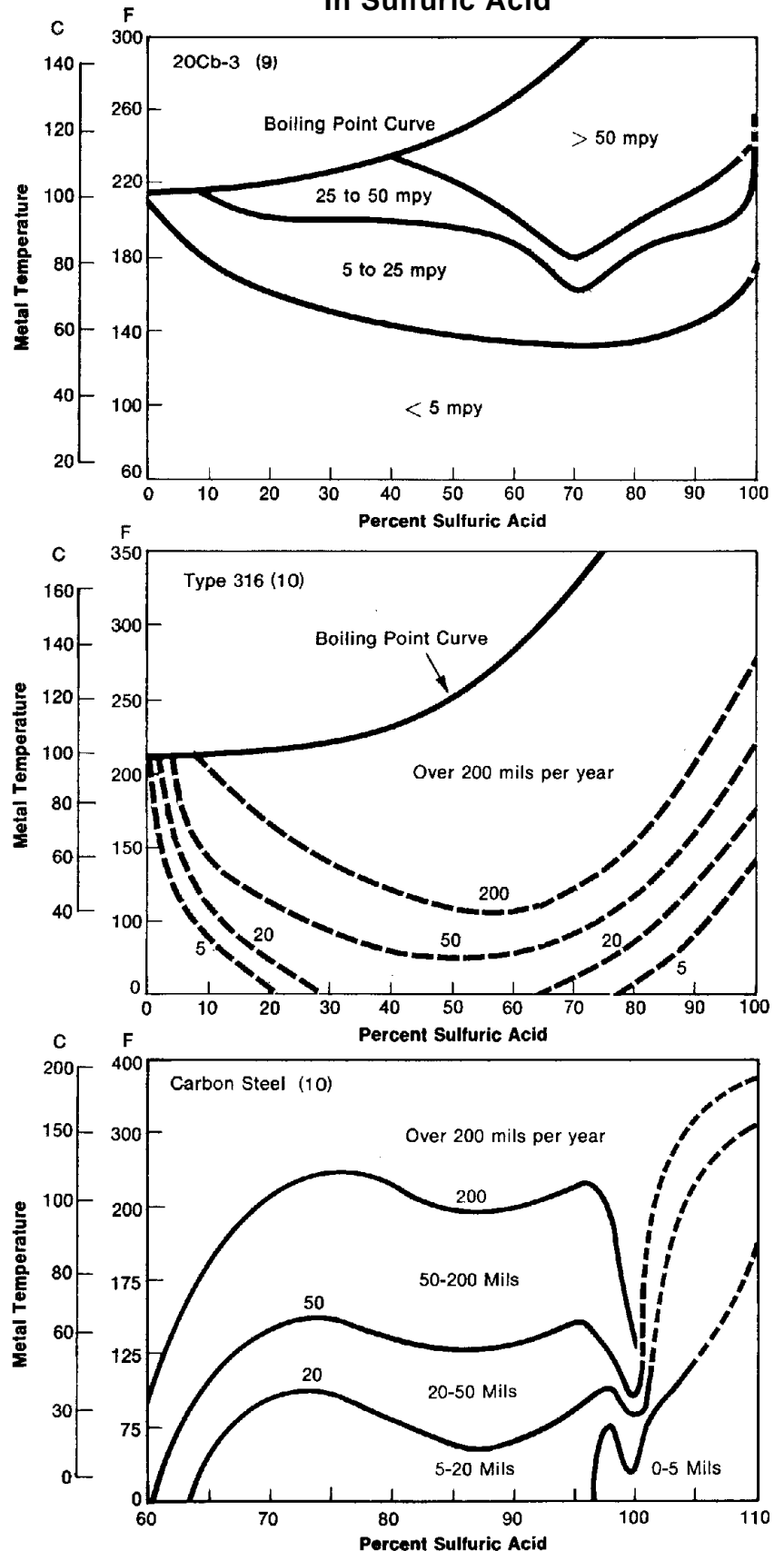
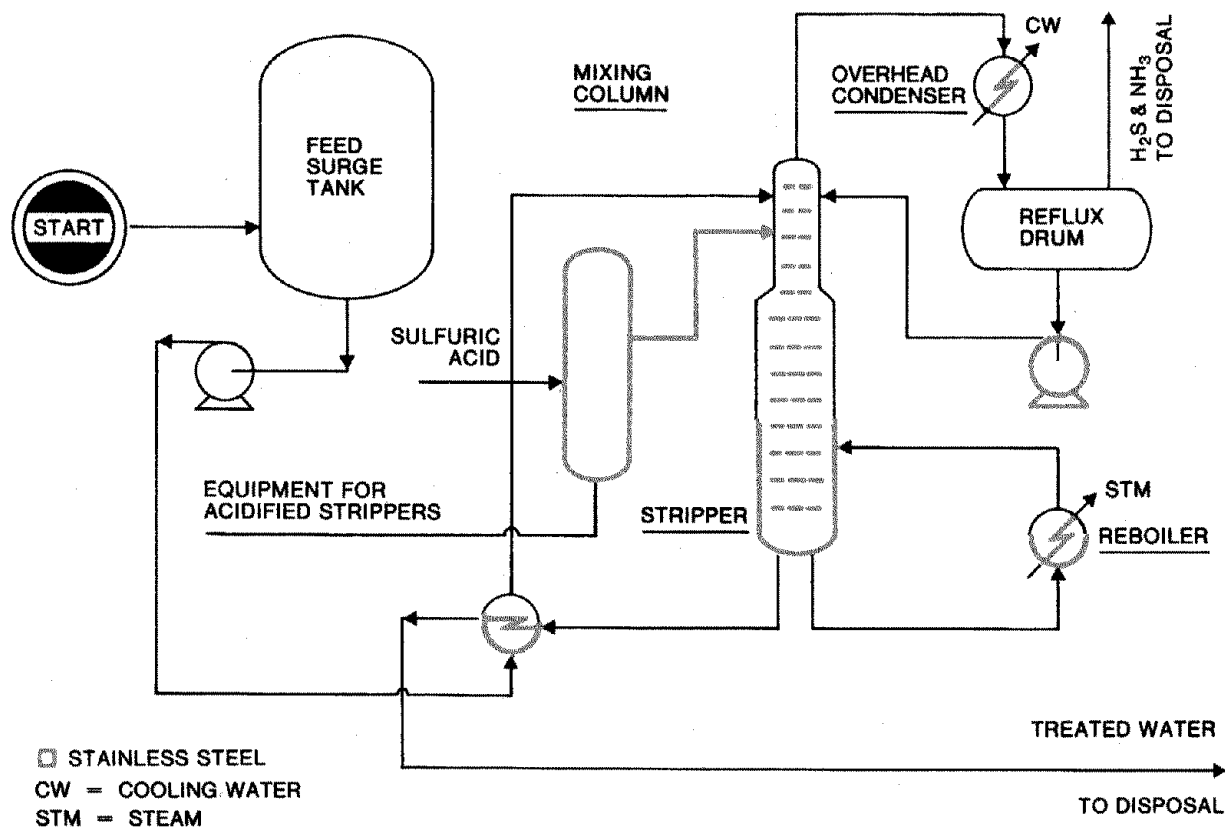

Figure 19  
**Sour Water Strippers  
 (Acidified)**



some refineries, sulfur dioxide is liberated from the traces of sulfate compounds and esters in the alkylate, resulting in corrosion and requiring the use of 316 or 20Cb-3. Reboiler tubing of 20Cb-3 is suggested due to heat flux, boiling and the possibility of chloride cracking. Type 316 should be considered for condenser tubing, linings and fractionation tray parts. These points for alloy consideration are shown as 5, 6, 7, 8, and 9 on the flow diagram, Figure 18.

Alloys such as 6X, 29-4-2, 29-4 and Nitronic 50 are candidates for some of the severest of services, e.g. reboiler tubing.

It is common practice in sulfuric acid alkylation to use 20Cb-3 and Alloy 20 for trim of valves, i.e. seats, discs and stems. Some refineries report Type 316 as being adequate, however. Mechanical seals of

the pumps and Stratco contactor are 316, 20Cb-3, and frequently nickel-base alloy for the delicate parts.

#### Sour Water Strippers

Sour water strippers are used to remove pollutants from various refinery waste-water streams. Pollutants include hydrogen sulfide, ammonia, carbon monoxide, carbon dioxide, cyanides, thiocyanates, phenols, salts, organic and inorganic acids, inhibitors, and some hydrocarbons.

In a basic stripper unit, steam, injected at the bottom, carries the gaseous pollutants overhead for further treatment. Overhead vapor is condensed and returned to the tower. Effluent water, which is relatively clean, is reused in the refinery or sent to final treatment in a refinery safety basin system. Heat exchangers are used to heat feed, reboiler effluent to produce steam, condense

overhead, and to recover heat.

The type and quantity of pollutants that have to be removed depend on the type of crudes handled in the refinery and the types of processes used. Consequently, sour water strippers encounter a wide variety of corrosive environments. However, the most common problem is sulfide corrosion from hydrogen sulfide, which is increased by the presence of cyanides.

There are three basic stripper types; acidified, nonacidified noncondensing, and nonacidified condensing. There are only a few acidified units, the rest are divided evenly between condensing and noncondensing strippers that use straight sour water feed without acid addition.

Discussing the acidified first, there are applications for stainless steel (Figure 20) primarily in the tower and the acid



Figure 20  
**Sour Water Strippers  
 (Non-Acidified)**

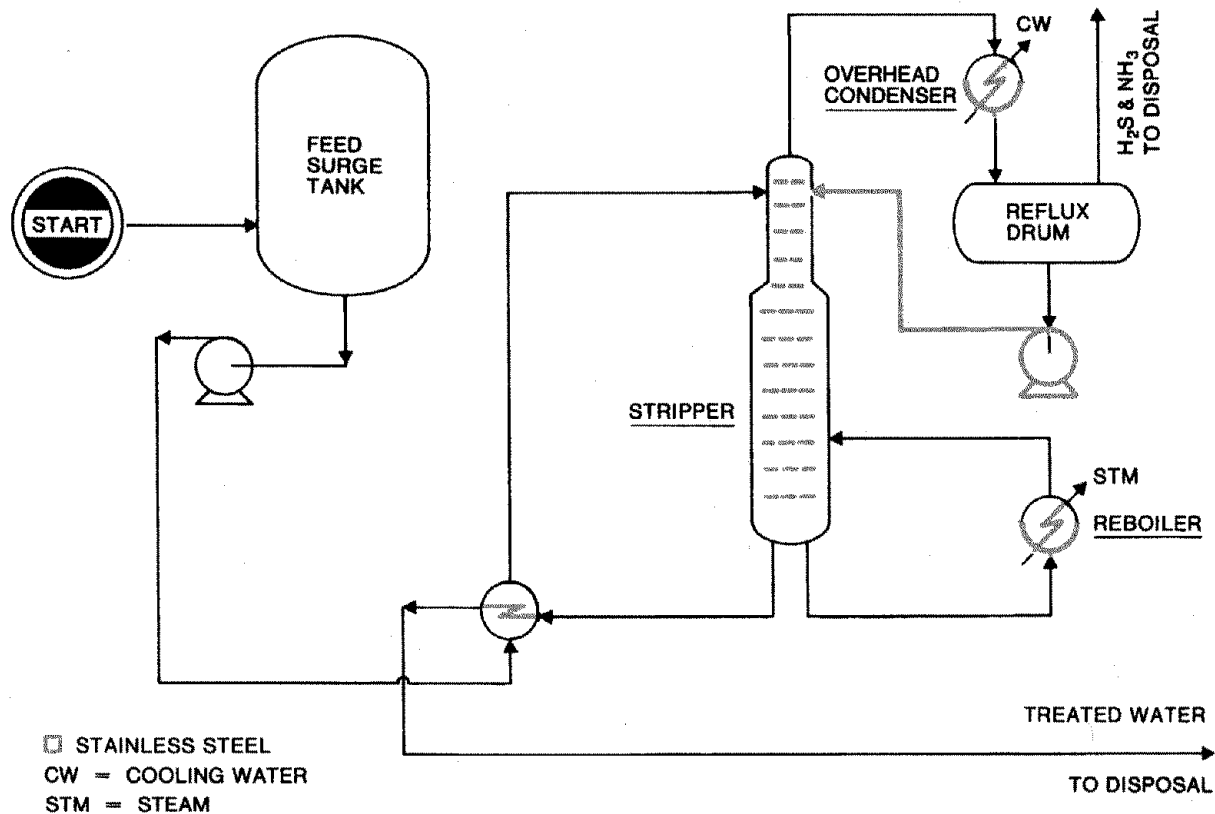

mixing column. By adding sulfuric acid to tie up ammonia, stripping of hydrogen sulfide is much more complete. Data show that Type 316 has adequate resistance to 20% sulfuric acid at low temperature, so it can be used in feed lines, tower, and trays. Alloy 20Cb-3 has been used for tower lining and trays also. In the mixing column, however, where acid concentration is higher, it would be more desirable to use higher alloyed material, such as 20Cb-3.

The overhead exchanger is either a tube-type unit or air cooler in which there may be plugging from ammonia bisulfide. As plugging occurs, velocities increase with a resulting increase in corrosion. Type 304 or 316 has been used in these units to minimize the problem.

Reflux drums are usually carbon steel. There have been some reports of

hydrogen blistering and cracking welds, but these problems can be controlled by controlling cyanides. Reflux pumps, however, usually require 20Cb-3 or a high-nickel alloy. If metallic control valves are used, these can be 304 or 316.

The effluent cooler is another stainless application. Although many coolers have been constructed of carbon steel, failures have been reported. Several tests indicate that Type 304 or 316 is adequate, remaining clean and not showing signs of deposits and pitting.

A nonacidified system is more alkaline, but this tends to drive the cyanides overhead along with ammonia and hydrogen sulfide. The tower can be carbon steel with a liberal corrosion allowance, but the trays should be stainless, either Type 410, 304, or 316. The overhead system, however, is very aggressive and high alloy materials

should be used, such as 6X, 29-4-2, 29-4, or titanium. The reflux lines in a nonacidified unit can be Type 304 or 316, and the bottom of the reflux drum can be stainless lined.

Reboilers to generate heat and steam for stripping are occasionally used in sour water stripping plants in place of direct steam introduction. Reboilers are used both for acidified and non-acidified units.

Reboiler service is very corrosive because polluted, salt-containing dirty water is being boiled. The environment is conducive to chloride stress-corrosion cracking and pitting under deposits on the tubes. Reboiler shells are lined with 316, 20Cb-3 or perhaps a more corrosion-resistant alloy.

Tubing candidate materials for reboilers are 6X, Nitronic 50, 29-4 or 29-4-2.

## STAINLESS STEELS

There are a total of 57 separate and distinct compositions that are recognized by American Iron and Steel Institute as standard stainless steels. Of these 57 types, 18 are being used for petroleum refining applications. The chemical compositions of these 18 are listed in Table 2 (Page 15).

### Metallurgical Structure

Stainless steels in the *Austenitic* group, containing chromium and nickel, are identified as AISI 300 Series types. Those containing chromium, nickel, and manganese, are identified as 200 Series types.

Although austenitic grades have different compositions, many have common characteristics. They can be hardened by cold working, but not by heat treatment. Annealed, all are nonmagnetic; however, some may become slightly magnetic on cold working. They have excellent corrosion resistance, mechanical properties (at ambient as well as low or elevated temperatures), and formability.

Type 304 (frequently referred to as 18-8) is the general-purpose stainless steel of the austenitic group with a nominal composition of 18% chromium and 8% nickel.

In the *Ferritic* group are the straight-chromium, 400 Series types that cannot be hardened by heat treatment, and are only moderately hardened by cold working. They are magnetic, and have good ductility and resistance to corrosion and oxidation. Type 430, nominally 17% chromium, is the general-purpose stainless of the ferritic group.

Figure 21  
ASME Boiler & Pressure Vessel Code  
Allowable Stresses (12)

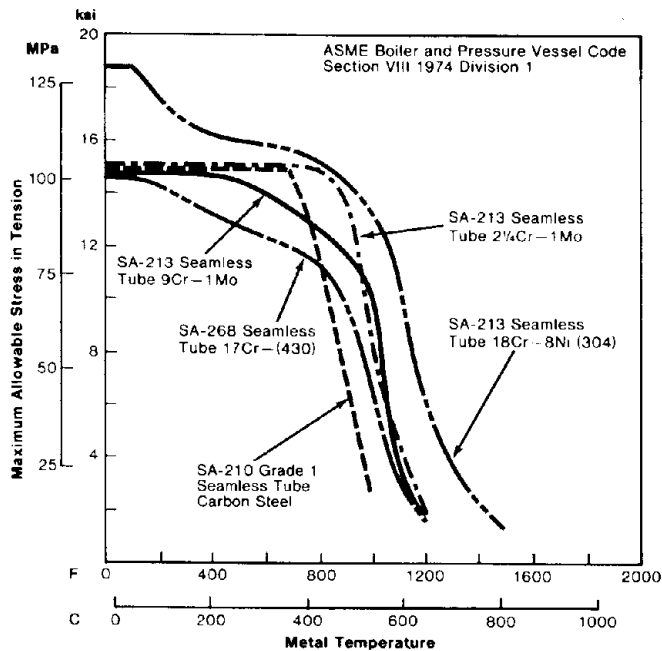

Figure 22  
Stress-Rupture Curves for  
Several Annealed Stainless Steels

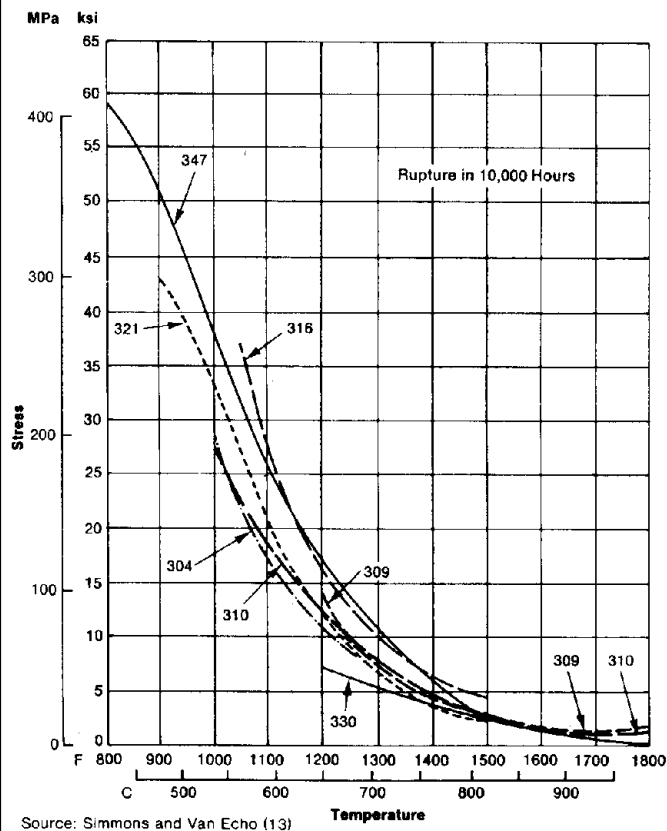
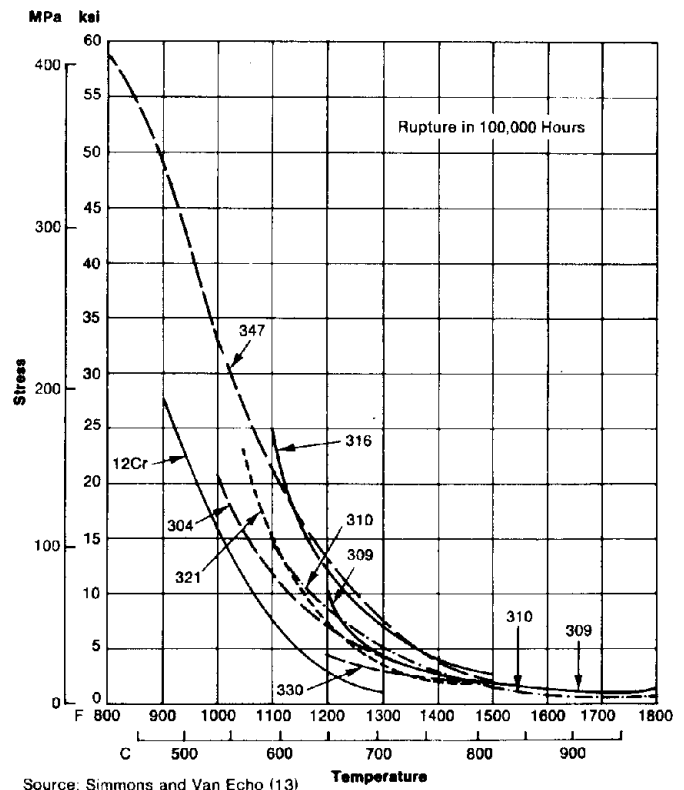

Figure 23  
Stress-Rupture Curves for  
Several Annealed Stainless Steels  
(Extrapolated Data)



In the *Martensitic* group are the straight-chromium 400 Series types that can be hardened by heat treatment. They are magnetic. They resist corrosion in mild environments, have fairly good ductility, and some can be heat treated to tensile strengths exceeding 200,000 psi (1379 MPa).

Type 410 with about 12% chromium is the general-purpose stainless steel of the martensitic group.

Representative mechanical properties of the 18 stainless steels most widely used in petroleum refining are shown in Table 3 (Page 17).

In addition to the AISI types, some proprietary stainless steels are

also candidate materials for petroleum refining applications. Their chemical compositions are listed in Table 4, and representative mechanical properties are shown in Table 5. Many of these are commercially available; however, a few are still being developed for commercial use. These few are mentioned because they show up well in laboratory tests for corrosion and elevated-temperature resistance and should be considered for some of the more-aggressive refinery applications.

### High-Temperature Mechanical Properties

Stainless steels are used routinely up to temperatures of 1500F

**Figure 24**  
**Creep-Rate Curves for Several Annealed Stainless Steels**

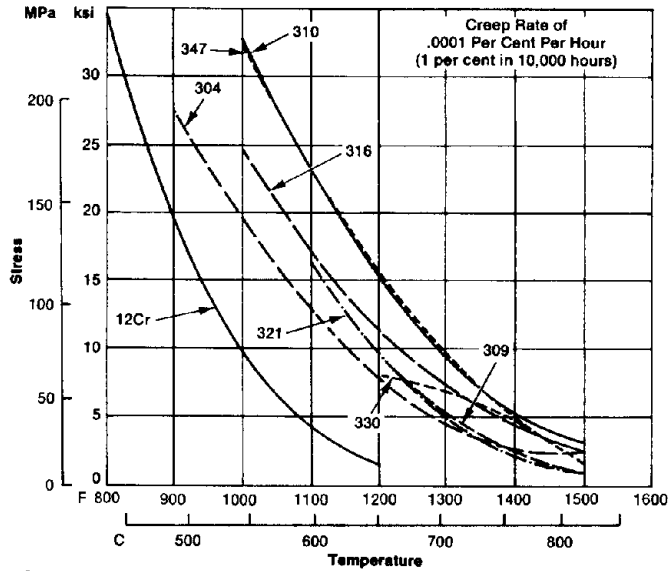

Source: Simmons and Van Echo (13)

**Figure 26**  
**Stress Versus Rupture-Time and Creep-Rate Curves for Annealed Type 304 Stainless Steel Based on Average data**

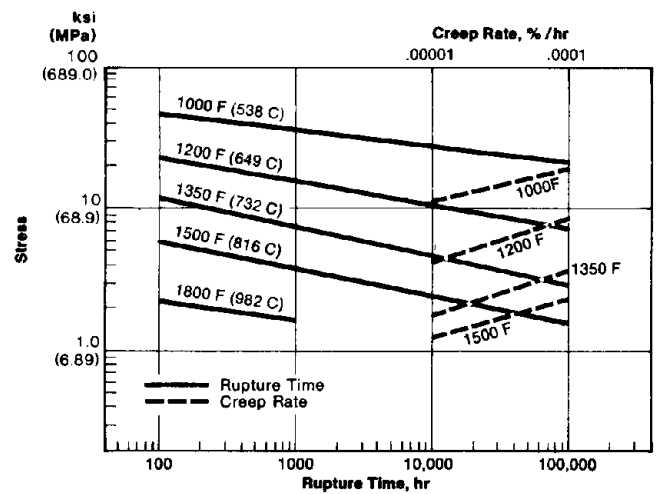

Source: Simmons and Van Echo (13)

**Figure 25**  
**Creep-Rate Curves for Several Annealed Stainless Steels**

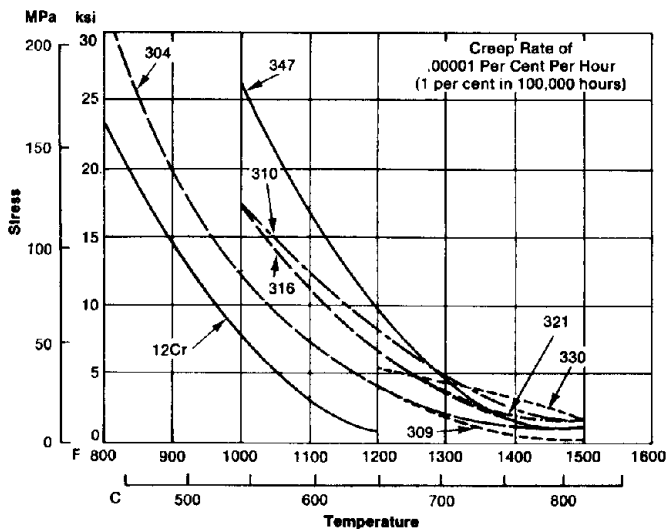

Source: Simmons and Van Echo (13)

**Figure 27**  
**Stress Versus Rupture-Time and Creep-Rate Curves for Annealed Type 309 Stainless Steel Based on Average Data**

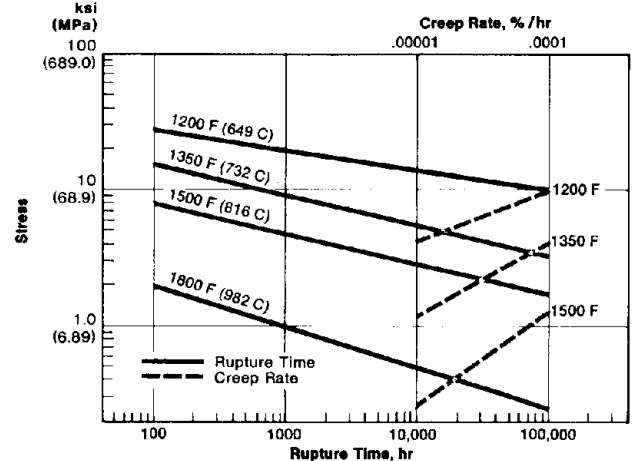

Source: Simmons and Van Echo (13)

(816C) because they possess good high-temperature strength, ductility, and resistance to high-temperature oxidation. Types 309, 310 and 330 are used in oxidizing environments at temperatures as high as 1800F (982C) quite frequently. In addition to high-temperature corrosion resistance, high-temperature strength and metallurgical stability (relative freedom from embrittlement) must be considered when selecting alloy for critical elevated-temperature applications.

Figure 21 shows the Allowable Design Stresses from the ASME Unfired Pressure Vessel Code, Section VIII Division 1 versus temperature for several austenitic stainless steels, ferritic stainless steels, chromium-molybdenum steels, and carbon steel. This graph portrays the value of chromium additions to steel for elevated temperature applications and the added advantage of nickel

plus chromium.

The design of loaded structures for service at low temperatures is generally based on yield strength or tensile strength properties determined at the temperature of application. Under these conditions, the metal behaves in an elastic manner.

At temperatures above 800F (427C), the behavior is different. Above 800F (427C), depending on the alloy, the steel will slowly permanently deform under the applied load or stress with a permanent measurable strain. The deformation with time is called creep. Under a sufficient load, the metal will creep and eventually rupture at the temperature of application.

The stresses that will cause rupture in 10,000 and 100,000 hours of several austenitic stainless steels are shown in Figures 22 and 23 as a function of temperature. Stresses that will cause creep

**Figure 28**  
**Stress Versus Rupture-Time and Creep-Rate Curves for Annealed Type 310 Stainless Steel Based on Average Data**

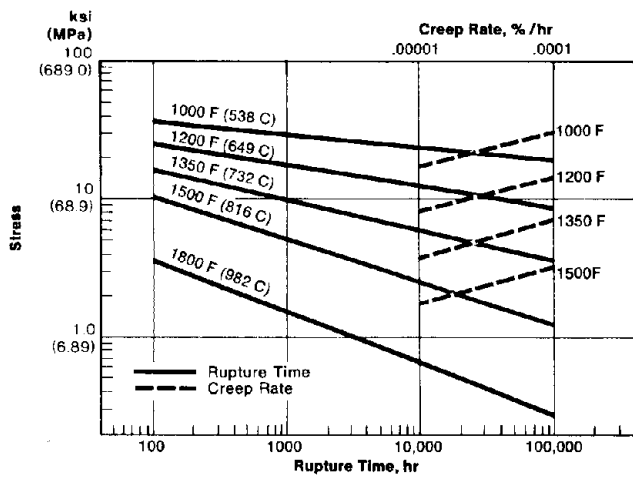

Source: Simmons and Van Echo (13)

**Figure 30**  
**Stress Versus Rupture-Time and Creep-Rate Curves for Annealed Type 321 Stainless Steel Based on Average Data**

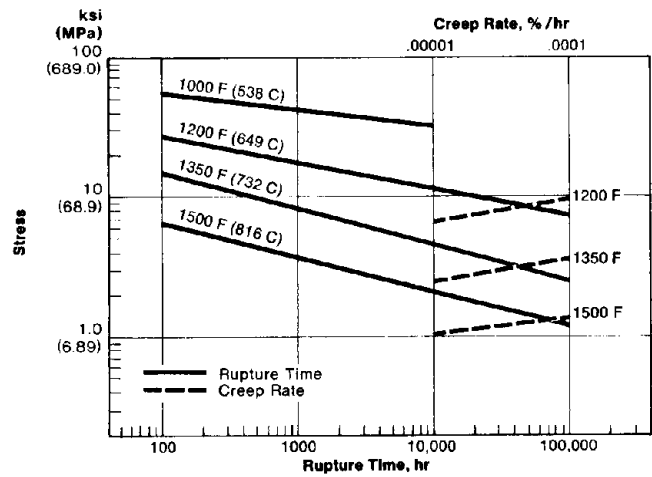

Source: Simmons and Van Echo (13)

**Figure 29**  
**Stress Versus Rupture-Time and Creep-Rate Curves for Annealed Type 316 Stainless Steel Based on Average Data**

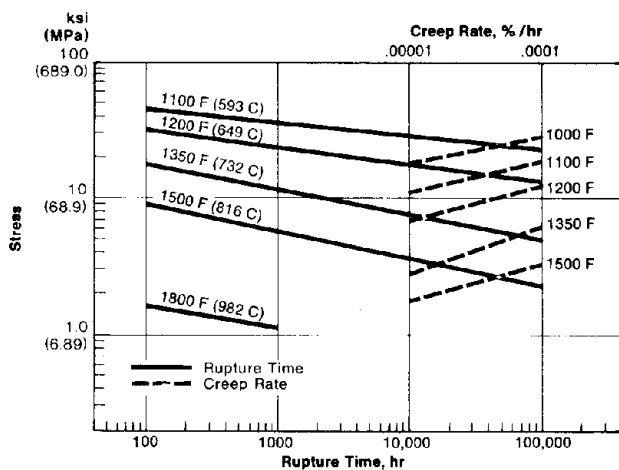

Source: Simmons and Van Echo (13)

**Figure 31**  
**Stress Versus Rupture-Time and Creep-Rate Curves for Annealed Type 330 Stainless Steel Based on Average Data**

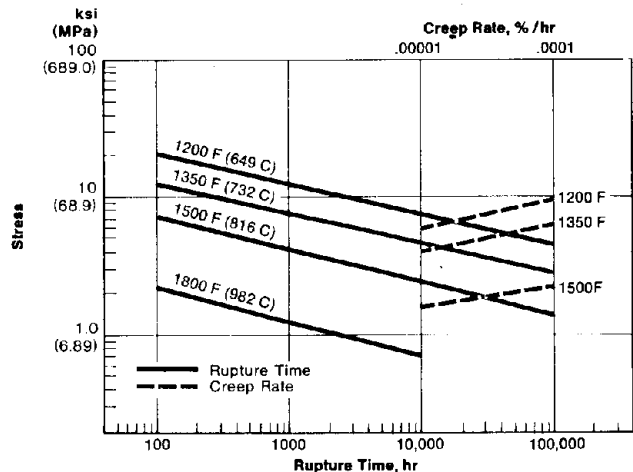

Source: Simmons and Van Echo (13)

at the rates of .0001 and .00001 per cent per hour are shown in Figures 24 and 25. Interpolation to other rupture times, creep rates, and stresses can be made by using Figures 26 to 34, which show the effects of applied stresses on the rupture times and creep rates for the same stainless steels at different temperatures.

Maximum allowable stress values for design of austenitic stainless steel for unfired pressure vessels are given in Section VIII, Division 1 and Division 2, of ASME Boiler and Pressure Vessel Code. The maximum allowable stresses as specified in the ASME Code are derived from stress versus rupture data employing rules providing suitable factors of safety.

**Thermal Conductivity.** Curves showing the average effect of temperature on the thermal conductivity of seven austenitic

stainless steels are shown in Figure 35. Heat transfer efficiency is a subject of increasing importance among refinery engineers because of the need to achieve closer to optimum performance in heat exchangers and thus economize on heat investment and energy utilization.

**Figure 32**  
**Stress Versus Rupture-Time and**  
**Creep-Rate Curves for Annealed Type 347**  
**Stainless Steel Based on Average Data**

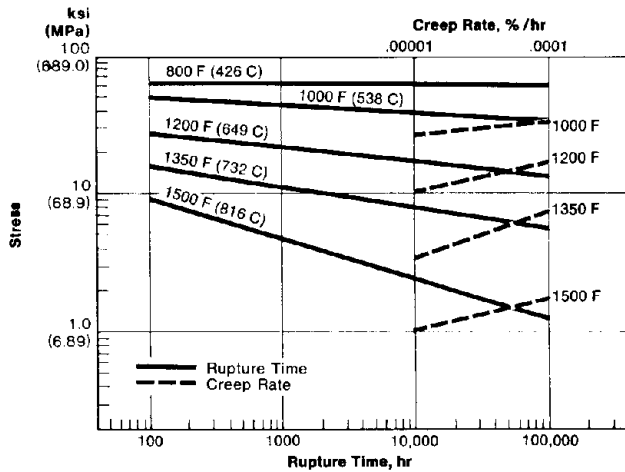

Source: Simmons and Van Echo (13)

**Figure 33**  
**Stress Versus Rupture-Time and**  
**Creep-Rate Curves for Type 410**  
**Stainless Steel Based on Average Data**

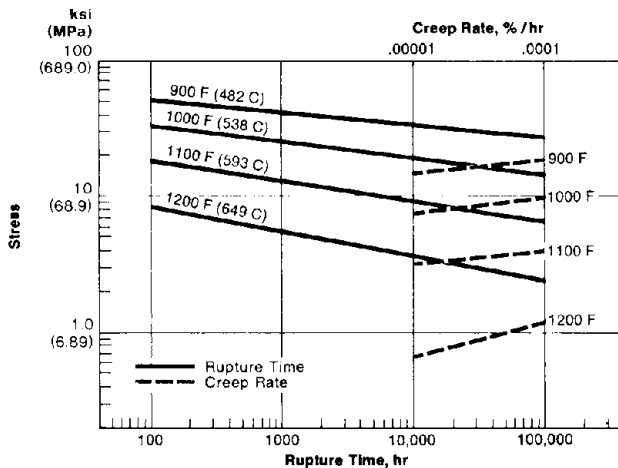

Source: Simmons and Cross (14)

**Figure 34**  
**Stress Versus Rupture-Time and**  
**Creep-Rate Curves for 17 Cr and 18 Cr**  
**Stainless Steel Based on Limited Data**

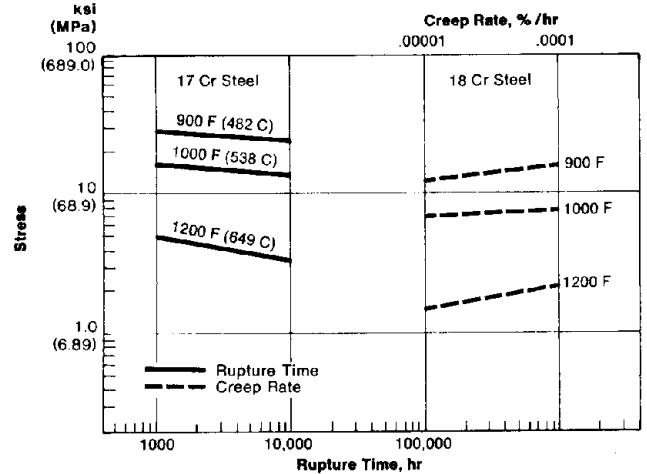

Source: Simmons and Cross (14)

**Figure 35**  
**Effect of Temperature on the Thermal**  
**Conductivity of Chromium-Nickel**  
**Stainless Steels**

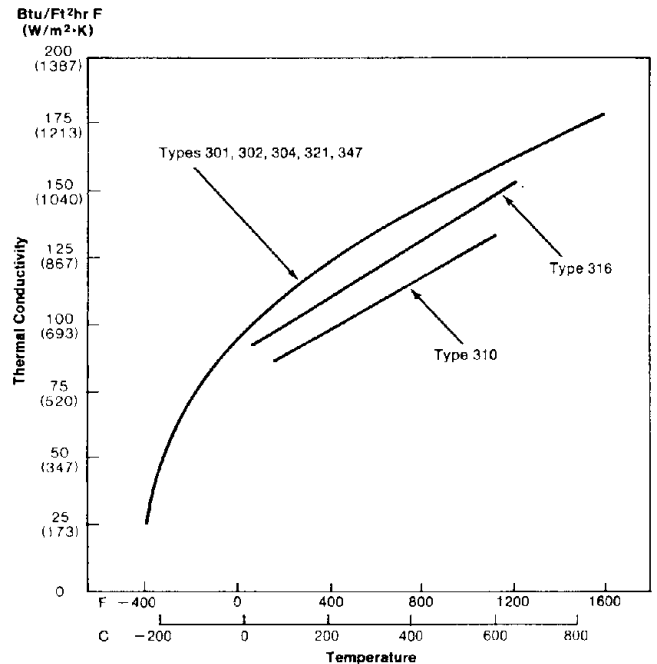

Source: The International Nickel Company (15)

## TYPES OF CORROSION

The types of corrosion occurring in petroleum refining processes are numerous, ranging from the “textbook” types, such as uniform corrosion, pitting, crevice, and erosion corrosion to the complex phenomenon of stress-corrosion cracking and high-temperature effects, such as sulfidation and oxidation. In addition, the high temperatures at which many refining processes operate can cause problems of embrittlement and carburization. Following is a brief description of several corrosion and high-temperature phenomenon, with comments on the use of stainless steels to avoid or minimize problems.

### Uniform Corrosion

During uniform attack the metal corrodes evenly. The attack may be rapid or slow, and it may leave the metal clean as with steel in sea water.

Frequently, stainless steels are chosen in lieu of structural steels because reduced corrosion is desired, and metallized coatings or cathodic protection are not practical.

Uniform corrosion is easy to evaluate from visual observation, weight loss, or thickness measurement.

### Pitting Corrosion

Pitting occurs when the protective oxide film or protective corrosion product on the surface of an alloy is destroyed in small localized areas. Once started, the attack may accelerate because of differences in electrical potential between the large area of passive surface (the cathode) versus the small area of the active pit (the anode). Carbon steel tank bottoms frequently pit at scratches and at welds because the iron oxide mill scale has been penetrated.

Type 304 stainless steel, for example, is susceptible to pitting when exposed to acid halide salts, such as might occur from ammonium chloride formed in crude atmosphere distillation overhead systems and in certain catalytic reformer condensing systems. However, Types 316 and 317 contain molybdenum (2-3% and 3-4% respectively) which reduces pitting tendency in halide environments. Also, several of the proprietary alloys listed in Table 4 are candidate materials for the severest of pitting environments. Some of these alloys are performing as well as titanium and nickel base alloys in seawater, for example.

### Crevice Corrosion

Crevice corrosion describes pitting

that results from local differences in oxygen concentration associated with crevices under gaskets, lap joints, and fasteners and with deposits that accumulate on metal surfaces. Once attack begins in a crevice, its progress is very rapid. It is most frequently associated with chloride environments, both neutral and low in pH. For this reason, the stainless steels containing molybdenum are often used to minimize the problem particularly in severe situations. Notwithstanding, the best solution to crevice corrosion is a design that eliminates or minimizes crevices. Because scaling or biological fouling can produce severe crevice conditions, a conscientious cleaning program can also help to minimize crevice corrosion attack.

### Intergranular Corrosion

When austenitic stainless steels are heated or cooled through the temperature range of about 800-1650F (427-899C), carbon migrates to the grain boundaries and combines with chromium forming chromium carbides. Called carbide precipitation, or

*Stainless steel clad tower 10'(3.1m) in diameter and 200' (61m) long with stainless ballast trays.*

*Photograph: Glitsch, Inc.*





Platformer fired heaters are prominent features of the Marathon Oil Company 200,000 BPD Garyville Refinery in Louisiana.

Photograph: Marathon Oil Company  
Ralph M. Parsons Company

sensitization, the effect is a depletion of chromium and the lowering of corrosion resistance in areas adjacent to the grain boundaries (Figure 36). This is a time-temperature dependent phenomenon, as indicated by Figure 37.

Sensitization may result from slow cooling from annealing temperatures, stress-relieving which occurs at sensitization range, or welding. Due to the longer time at temperature of annealing or stress-relieving which occurs at sensitization range, or welding. Due to the longer time at temperature of annealing or stress-relieving, it is possible that the entire piece of material will be sensitized, whereas the shorter time at temperature characteristic of welding can result in sensitization of a band, adjacent to but slightly removed from the weld. This region is known as the heat-affected-zone or HAZ.

Intergranular corrosion (sometimes known as sugaring) depends upon the magnitude of the sensitization and the aggressiveness of the environment to which the sensitized material is exposed. Many environments do not cause intergranular corrosion in sensitized austenitic stainless steels; for example, glacial acetic acid at room temperature, alkaline salt solution such

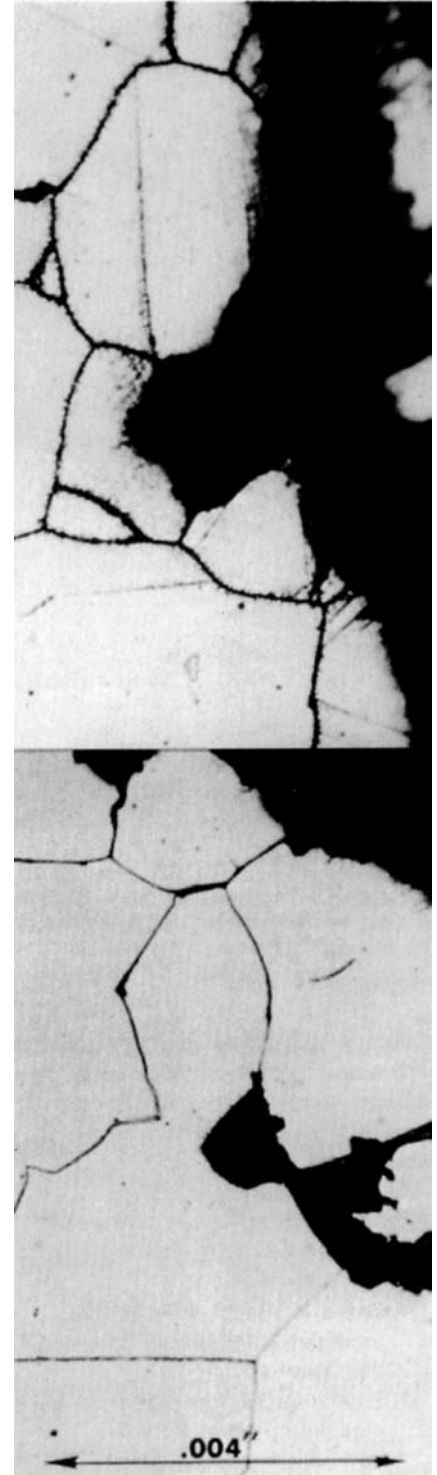
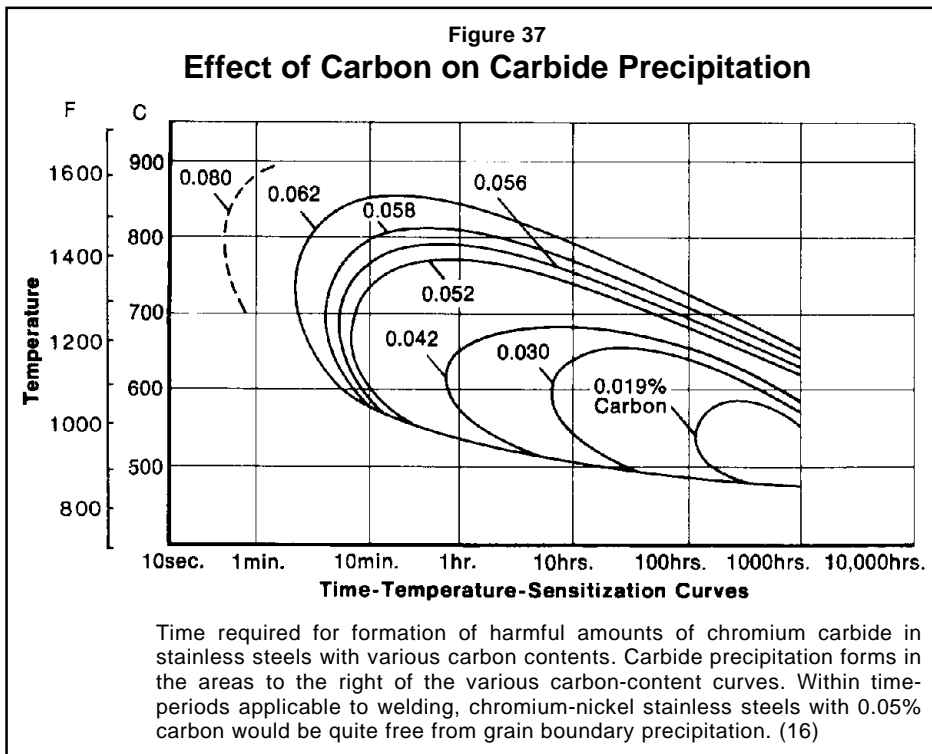
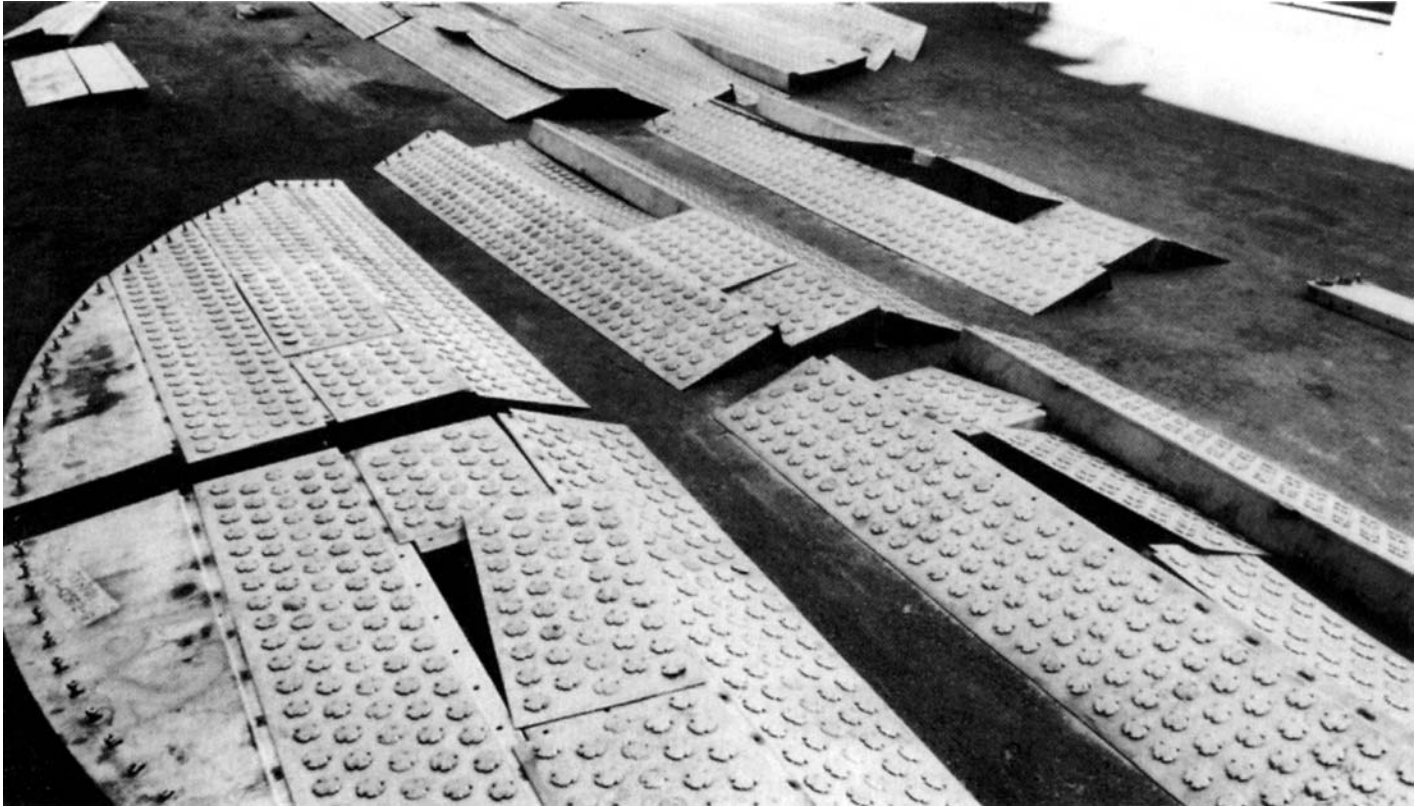

Figure 36  
Intergranular attack on Type 316 stainless steel, which has resulted from carbide precipitation (or sensitization). Sensitization of austenitic stainless steels may occur when they are heated or cooled through a temperature range of about 800-1650F (427-899C). Stabilized or low-carbon grades, such as Type 347 or 316L, prevent carbide precipitation.





*Valve cap trays fabricated of Type 410 stainless steel are being assembled for installation in a crude distillation tower.*

**Photograph: Glitsch, Inc.**

as sodium carbonate, potable water and most inland bodies of fresh water. For such environments it would not be necessary to be concerned about sensitization.

Carbide precipitation and intergranular corrosion in austenitic stainless steels can be minimized by the following methods:

1. Use of stainless steel in the annealed condition or annealing after fabrication.
2. Selection of a low-carbon (0.030% maximum) grade for weld fabrication, such as 304L, 316L, or 317L.
3. Use of a stabilized grade, such as Type 321 (titanium stabilized) or Type 347 (columbium stabilized). The protection obtained with these grades is based upon the fact that titanium and columbium have a greater affinity for carbon than does chromium. (Although less susceptible, the stabilized grades

can also be sensitized, however, by exposure to high temperatures over extended periods of time. This problem is discussed under the section "Polythionic StressCorrosion Cracking.")

4. Use a stabilized grade, such as Type 321 or 347, if it is desired to stress relieve after fabrication to avoid chloride stress-corrosion cracking.

It should be understood that the above steps are necessary only if the service environment is capable of causing intergranular corrosion.

Although the ferritic stainless steels can be sensitized by exposure to temperatures above 1700F (927C), they are seldom used at this temperature in petroleum refining. However, sensitization can occur in the HAZ during welding. Several of the proprietary ferritic stainless steels either have low carbon content or are stabilized to prevent sensitization during welding.

### **Stress-Corrosion Cracking**

Stress-corrosion cracking is not fully understood, although laboratory studies and service experience have revealed

some generally accepted criteria for it to occur. These criteria are:

1. A susceptible alloy and metallurgical condition
2. Tensile stress
3. Damaging environment
4. Time.

Table 6 serves to emphasize the fact that stress-corrosion cracking is not restricted to stainless steels but occurs in practically all alloy systems.

A major factor in stress-corrosion cracking is the presence of a tensile stress: either residual stress from fabrication, or operation stress, or a combination of both. Residual stresses are particularly dangerous because they are normally of greater magnitude, often approaching the yield point, as in the case of welded components.

Tensile stresses can be relieved by proper heat treatment. Fabricated austenitic stainless steels, for example, can be stress relieved by heating between 1550-1650F (843-899C). This treatment can cause carbide precipitation in the regular carbon, nonstabilized grades, so it would be more desirable to use a low-carbon or stabilized grade.



For austenitic stainless steels, the most damaging environment is chloride concentration at elevated temperature (18). Service experience and laboratory studies indicate that if heat is applied to such a degree as to cause evaporation or alternate wetting and drying, chlorides will concentrate, thus increasing the probability of stress-corrosion cracking. Supporting this observation is the fact that austenitic stainless steels have not been known to crack in strong chloride environments at ambient temperature, nor at elevated temperature under condensing, or diluting circumstances.

Time is usually a factor, but cracks have been known to form and propagate as fast as 0.05-10 mm per hour.

Also, it has been shown that oxygen is necessary. While oxygen content cannot be reduced sufficiently in laboratory tests to prevent cracking, tests with geothermal steam condensate have clearly demonstrated that oxygen must be present in the cracking solution.

Since there is no practical way to stop stress-corrosion cracking after it starts, the best defense is to select an alloy that resists cracking and then to control the environment to prevent conditions that

are known to cause stress-corrosion cracking.

For instance, Copson (19) demonstrated that the nickel content of stainless steels is very important, as shown in Figure 38. The susceptibility of austenitic stainless to stress-corrosion cracking is pronounced at nickel contents of 8-12%. Decreasing the nickel content, as in Type 329, or increasing it above 32%, as in Type 330, increases the resistance to chloride-stress corrosion cracking. Also, proprietary grades 20Cb-3 and 6X and the high-nickel alloys have demonstrated resistance to stress-corrosion cracking. Uhlig and

White (20) and Loginow and Bates have shown that reduced nitrogen and increased silicon content enhance resistance to chloride stress-corrosion cracking, as in stainless steel 18-18-2. Recent studies by Climax Molybdenum Company indicate that high molybdenum levels as found in Type 317 with 3.5% minimum molybdenum have excellent resistance.

From a practical standpoint, Type 304 may be adequate under certain conditions. For instance, Type 304 is being used in water containing 100-300 parts per million (ppm) chlorides at moderate temperatures. Lancaster (21)

**Figure 38**  
**Effect of Nickel on**  
**Stress-Corrosion Cracking**

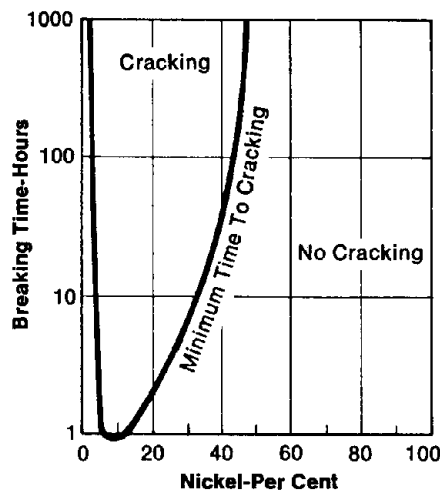

Annealed Wire Loaded to Range of 33,000-45,000 PSI in Tension.

Cracking time for iron-nickel-chromium wires in boiling 42% magnesium chloride.

Source: Copson (19)

TABLE 6	
Alloy Systems Subject to Stress-Corrosion Cracking	
ALLOY	ENVIRONMENT
ALUMINUM BASE	<ul style="list-style-type: none"> <li>• AIR</li> <li>• SEAWATER</li> <li>• SALT &amp; CHEMICAL COMBINATIONS</li> </ul>
MAGNESIUM BASE	<ul style="list-style-type: none"> <li>• NITRIC ACID</li> <li>• CAUSTIC</li> <li>• HF SOLUTIONS</li> <li>• SALTS</li> <li>• COASTAL ATMOSPHERES</li> </ul>
COPPER BASE	<ul style="list-style-type: none"> <li>• PRIMARILY AMMONIA &amp; AMMONIUM HYDROXIDE</li> <li>• AMINES</li> <li>• MERCURY</li> </ul>
CARBON STEEL	<ul style="list-style-type: none"> <li>• CAUSTIC</li> <li>• ANHYDROUS AMMONIA</li> <li>• NITRATE SOLUTIONS</li> </ul>
MARTENSITIC & PRECIPITATION HARDENING STAINLESS STEELS	<ul style="list-style-type: none"> <li>• SEAWATER</li> <li>• CHLORIDES</li> <li>• H<sub>2</sub>S SOLUTIONS</li> </ul>
AUSTENITIC STAINLESS STEELS	<ul style="list-style-type: none"> <li>• CHLORIDES-INORGANIC &amp; ORGANIC</li> <li>• CAUSTIC SOLUTIONS</li> <li>• SULFUROUS &amp; POLYTHIONIC ACIDS</li> </ul>
NICKEL BASE	<ul style="list-style-type: none"> <li>• CAUSTIC ABOVE 600°F (315°C)</li> <li>• FUSED CAUSTIC</li> <li>• HYDROFLUORIC ACID</li> </ul>
TITANIUM	<ul style="list-style-type: none"> <li>• SEAWATER</li> <li>• SALT ATMOSPHERES</li> <li>• FUSED SALT</li> </ul>
(Simplified: See Logan, H. L. "The Stress Corrosion of Metals". John Wiley & Sons, for Comprehensive List.) (17)	

in the January 1975 issue of *Hydrocarbon Processing* proposed a chart (Figure 39) that relates time to failure with chloride concentration and temperature. The lines represent an average for any given temperature with probable scatter on either side, and they need to be used with a safety factor of about ten times chloride content. With such a safety factor, Lancaster suggests that the limiting chloride content for water in a Type 304 cooler – for a life of 100,000 hours – is 300 ppm. Trying to establish limits can be risky because wet/dry conditions can concentrate chlorides and increase probability of stress-corrosion cracking. More information, particularly for long exposures at 300F (149C) and below, is needed to apply the chart with confidence; meanwhile it is a rough guide.

Another answer to avoiding stress-corrosion cracking environments may be to use a straight-chromium, ferritic stainless steel, such as Type 405, 430, or one of the proprietary ferritic grades described earlier. There are a number of corrosive environments in petroleum refining in which Type 430 has good resistance.

**Cracking in Polythionic Acid**

A special form of stress-corrosion cracking, actually a form of accelerated intergranular corrosion, can occur in sensitized austenitic stainless steels exposed to polythionic acid at room or slightly elevated temperature. Only modest tensile stress is required. Generally, the stress-corrosion cracking in polythionic acid is intergranular (Figure 40), whereas chloride stress-corrosion cracking is usually transgranular (Figure 41). Unless suitable precautions are taken, austenitic stainless steels, which have been exposed in a sensitizing temperature range of 800-1500F (427-816C), are likely to be susceptible to failure.

According to Samans (3), polythionic acid solutions can readily form in petroleum refining units during shutdown. Only the interaction of sulfide, moisture, and oxygen is required. Iron sulfide, as a corrosion product and/or as hydrogen sulfide, is present in numerous units, desulfurizers in particular.

Sufficient moisture is available even from general humidity, or more usually from washing or steaming out units as a normal shutdown precaution. Oxygen is available from the air that enters when a unit is opened.

Intergranular stress-corrosion cracking in polythionic acid has been reported in a number of different refining processes(2) (22). Its recognition as an industry-wide problem coincided with the increase in catalytic reforming

capacity during the 1950's. Failures appear to be most common in reforming equipment, but polythionic acid cracking is considered a possibility in almost any petroleum refining process using austenitic stainless steels.

Tests by Piehl suggest that the sulfur acids responsible for polythionic acid stress-corrosion cracking are among the most vigorous cracking agents known, as cracking can occur in well under one hour at moderately low temperature.

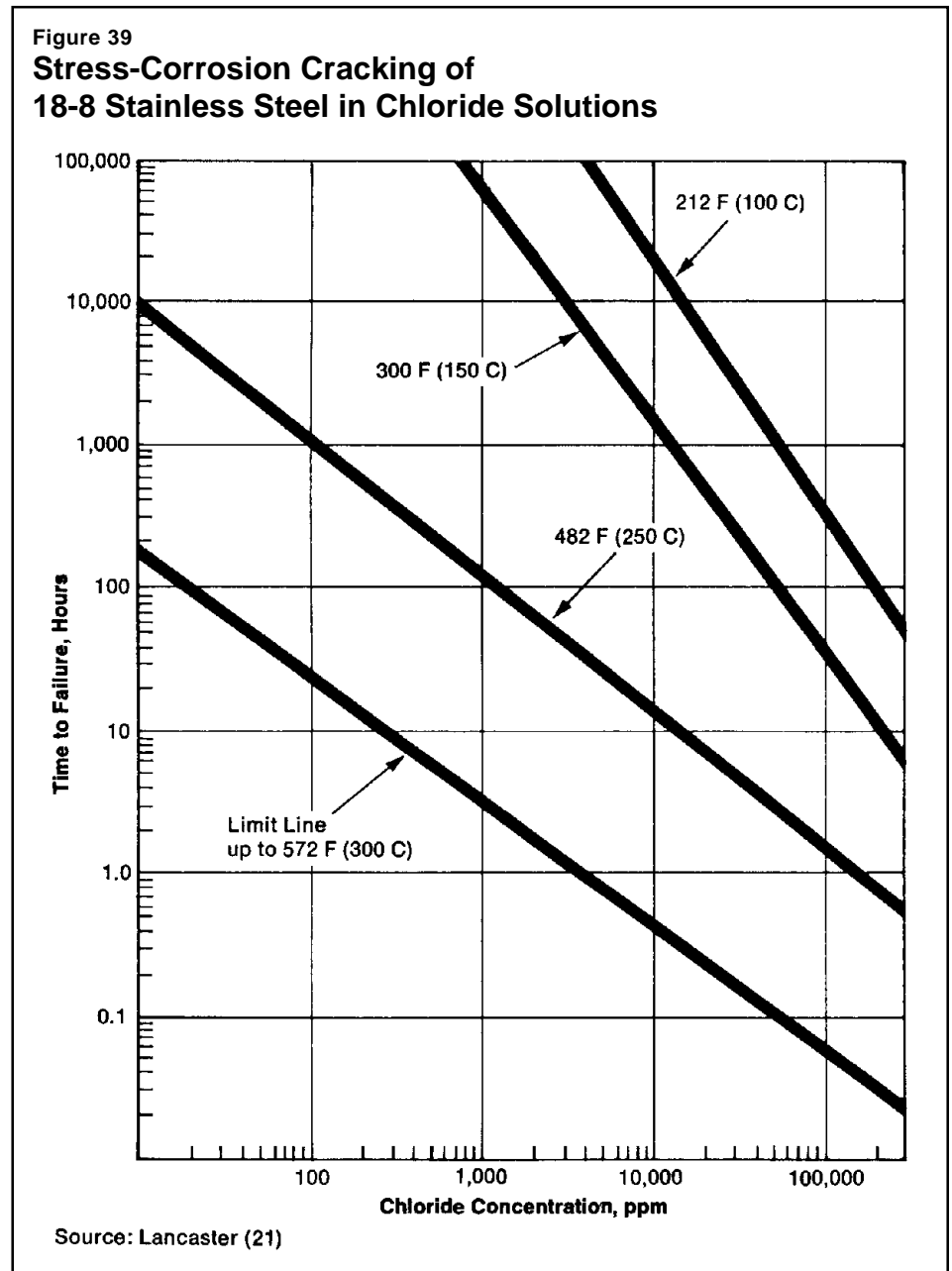

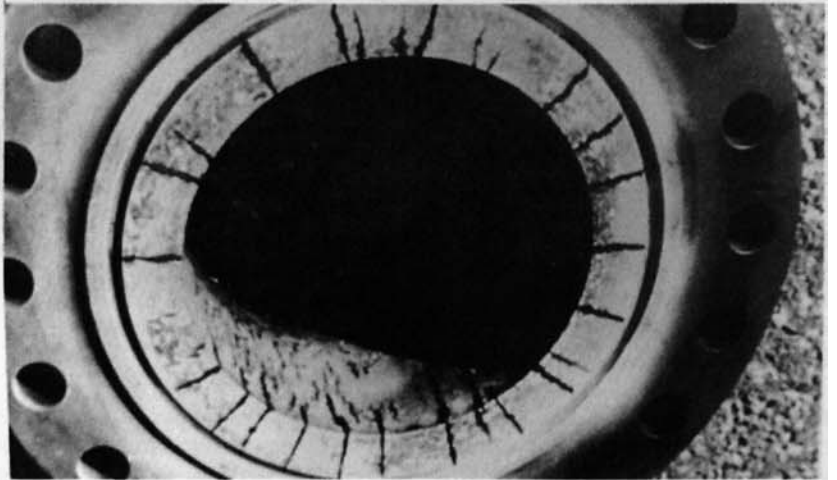
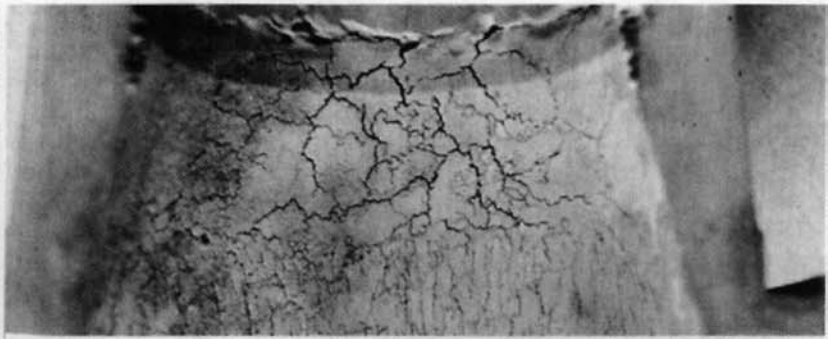
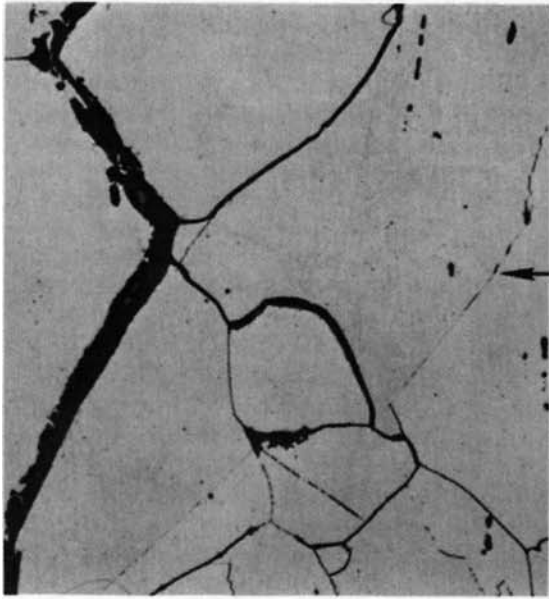

**Figure 40**

*Photomicrograph of intergranular stress-corrosion cracking, as might occur in polythionic acid. Types 321 and 347 are used to help prevent such attack. NACE suggests use of neutralizing solutions during shutdown to prevent formation of polythionic and other sulfur-base acids.*

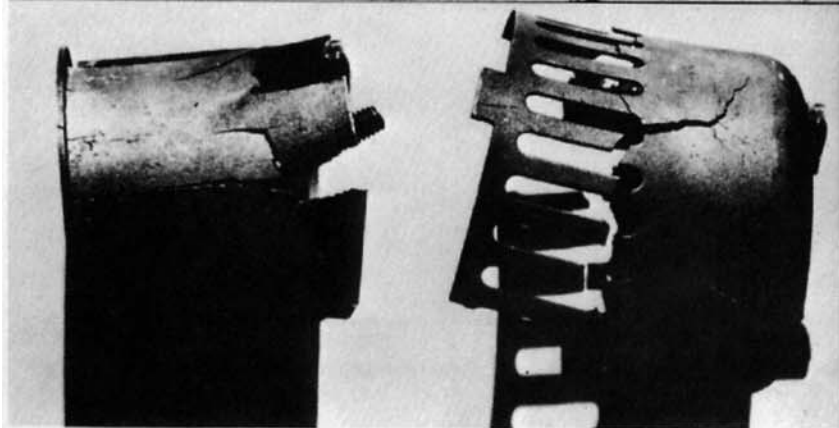
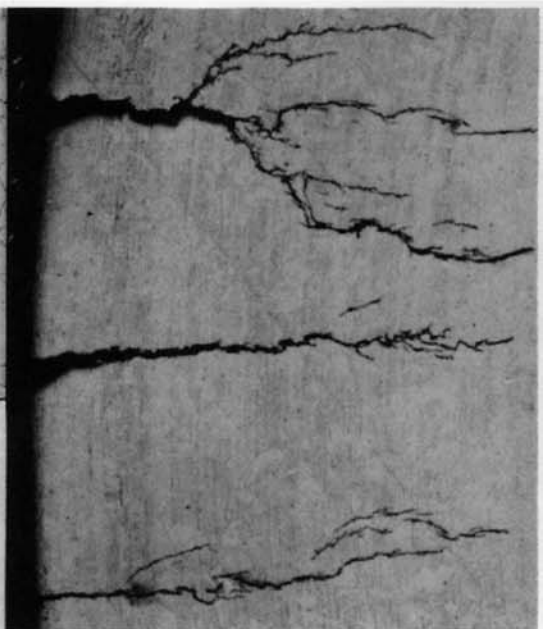
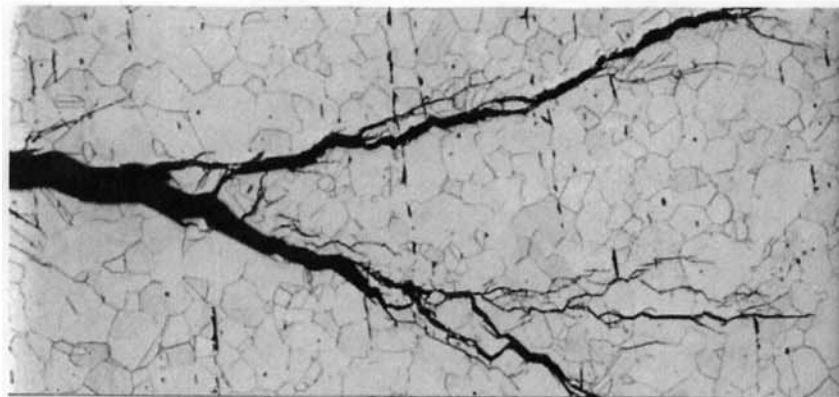

**Figure 41**

*Photomicrograph of transgranular stress-corrosion cracking, as might occur in chloride environments. Tensile stress, such as found in highly deformed bubble caps, is also a major factor in chloride stress-corrosion cracking.*

Figure 42 shows results of sensitization tests on Types 304, 304L, 321, and 347. It is apparent that sensitization of Type 304 occurs rapidly at the highest temperature indicated in Figure 42. Type 304L shows evidence of sensitization after 100 hours at 1000-1100F (538-593C), and it is definitely sensitized after 1000 hours.

It is interesting to note that Type 321, which is stabilized with titanium, may become sensitized in less than 1000 hours. Type 347, on the other hand, is sensitized only in a relatively narrow temperature range, and only for exposures of greater than 1000 hours.

Samans reports that heat treating Types 321 and 347 in the range 1550-1700F (843-927) for at least four hours will improve their stability against polythionic acid corrosion. This stability continues for solution annealing in the range 1700-2000F (927-1093C), but not in the range of 2100-2200F (1149-1204C).<sup>(5)</sup> (Types 321 and 347 probably should be considered separately because the solubility of columbium carbides tends to require about 200F more than titanium carbides

for the same effects.)

It is concluded that austenitic stainless steels exposed to continuous service below 800F (427C) may be susceptible to polythionic stress-corrosion cracking only if they are sensitized by welding or heat treatment, in which case cracking can be avoided by using low-carbon or stabilized grades. For service above 800F (427C), equipment may become sensitized by long exposure times, so care should be exercised in selecting a material that is most resistant for the intended service.

Proper shutdown procedures are also an effective deterrent to downtime corrosion problems. The National Association of Corrosion Engineers suggests a procedure; it is Standard PR-01-70, "Recommended Practice for Protection of Austenitic Stainless Steels in Refineries Against Stress Corrosion Cracking by Use of Neutralizing Solutions During Shut Down."

### Naphthenic Acid

Naphthenic acid is a collective name for organic acids present in crude oils from California, Romania, Russia, and

some parts of Texas and the Arabian peninsula. About 25-30% of the refineries have problems with naphthenic acid, but this number can increase because a growing number of refiners are making spot purchases of crude from different sources.

Naphthenic acid corrosion is of concern when the neutralization number of the feedstock is above 0.5\*, when distillation temperatures are 430-750F (221-399C), and when fluid velocities are high – especially in transfer lines and return bends. \*(The neutralization number is expressed as milligrams of potassium hydroxide (KOH) required to neutralize acid in a one-gram sample.)

Absence of scale and a characteristic grooving of the steel (Figure 43), as if it were caused by erosion, is often the sole evidence of naphthenic acid corrosion. The problem is usually most severe in vacuum units and atmospheric distillation units, and it is found to some extent in thermal cracking units, especially in columns, piping, heaters, heat exchangers and pumps.

Naphthenic acid corrosion problems are minimized by neutralization with

Figure 42 **Time/Temperature-Sensitization Diagram for Types 304 & 304L Stainless Steels**

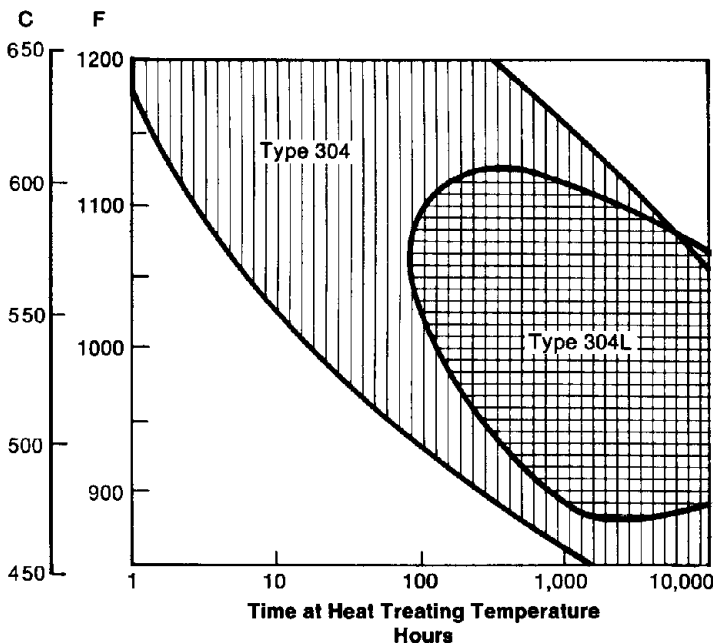

Source: Piehl (2)

**Time/Temperature-Sensitization Diagram for Types 321 & 347 Stainless Steels**

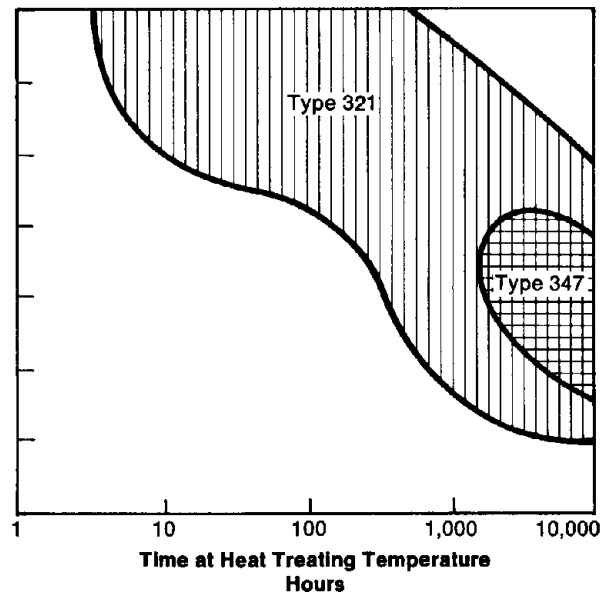

Source: Piehl (2)

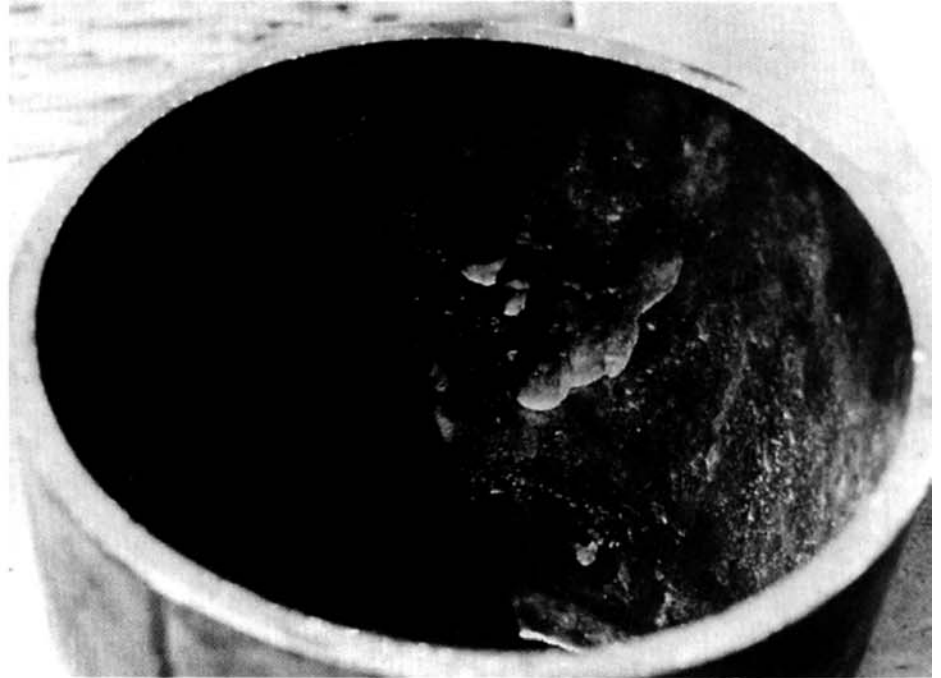

**Figure 43**  
*Absence of scale and grooving of the metal surface are characteristic of naphthenic acid corrosion of carbon steel. Type 316 stainless steel has excellent resistance to attack by naphthenic acid.*



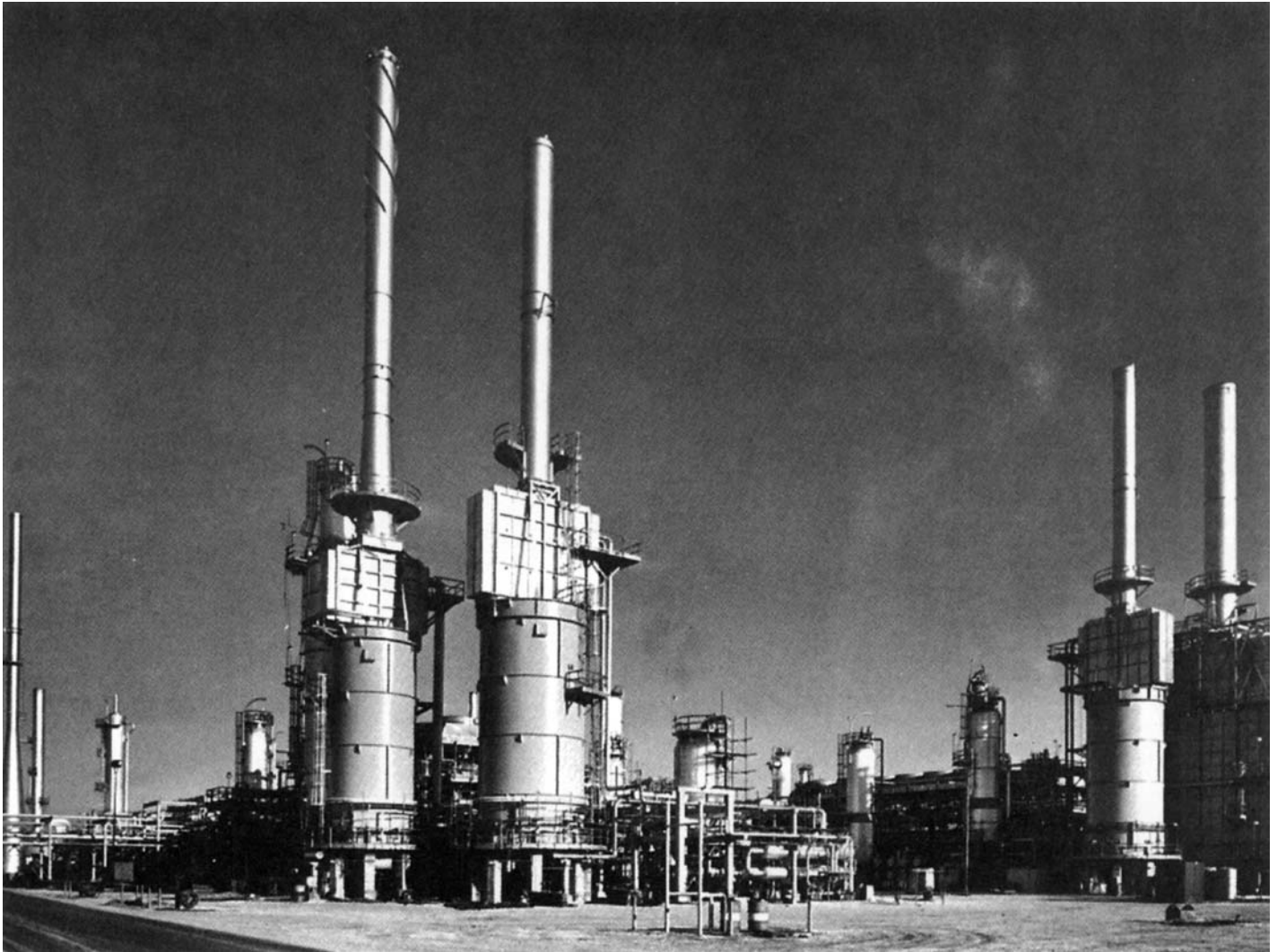

*Light gas oil Hydrobon heaters (left) with heavy gas oil Hydrobon unit on far right.  
Photograph: Marathon Oil Company  
Ralph M. Parsons Company*

**TABLE 7**  
**Corrosion Rates in Naphthenic Acid (7248 Hours)**  
Heavy Gas Oil, Vacuum Tower, 520F (271C),  
Acid or Neutralization Number 3.9

Alloy	mpy	mmpy	Alloy	mpy	mmpy
Carbon Steel	>25	0.635	216	0.01	0.0003
Type 410	>21	0.533	Hastelloy 13 <sup>(1)</sup>	0.02	0.0005
Type 430	12.4	0.315	825	0.002	0.0001
600	17.2	0.437	20Cb-3 <sup>(2)</sup>	0.012	0.0003
Type 304	13.7	0.348	Hastelloy G <sup>(1)</sup>	0.01	0.0003
800	11.2	0.284	Jessop 700 <sup>(3)</sup>	0.008	0.0002
Type 316	0.046	0.0012	625	0	0
Type 317	0.024	0.0006	Hastelloy C <sup>(1)</sup>	0.002	0.0001

Source: Standard Oil Company of California (23)

<sup>(1)</sup>Trademark, Cabot Corporation

<sup>(2)</sup>Trademark, Carpenter Technology Corporation

<sup>(3)</sup>Trademark, Jessop Steel Corporation

caustic soda, modifying velocity conditions, and proper material selection, such as Type 316 stainless steel. Table 7 shows the corrosion rates for several materials exposed in a heavy gas oil vacuum tower at 520F (271 C), and Figure 44 illustrates the effect of composition and stream velocity on corrosion rate of crude oil containing naphthenic acid.

The data show that Type 316 and other molybdenum-bearing stainless steels are effective in naphthenic acid environments. Because Type 316 also

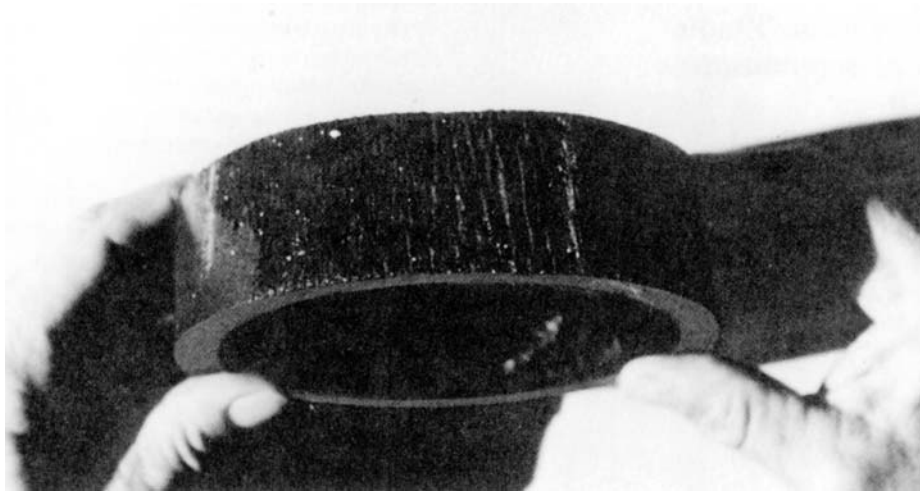

**Figure 45**  
*This furnace tube, highly coked, over heated and cracked as a result of severe oxidation. Chromium in stainless steels is an important alloying element in increasing resistance to high-temperature oxidation.*

resists the effects of sulfidation, it is an excellent candidate material. As the molybdenum content of an alloy increases, the resistance to naphthenic acid shows an increase.

### Oxidation

A petroleum refinery has a large number of fired heaters for heating crude oils and other hydrocarbon liquids and vapors in order to distill or crack (pyrolyze) them as the case may be. Most refineries have power boilers providing steam for drivers and a multitude of process functions. Most refineries have fluid catalytic cracking plants which in turn employ regenerators for reconstituting catalyst by burning coke on catalyst at temperatures of 1400F (760C).

Furnace tubes, boiler tubes, tube supports and hangers and re-radiating cones, all within a firebox, are subject to high-temperature oxidation scaling (Figure 45).

With carbon steel, the amount of scaling in air is negligible below about 1000F (538C). Above this temperature, the rate of scaling of carbon steel increases rapidly.

The most important alloying element for increasing scaling resistance above 1000F (538C) is chromium. This element appears to oxidize preferentially to iron. It forms a tightly adherent layer of chromium-rich oxide on the surface of the metal, retarding the inward diffusion of oxygen and inhibiting further oxidation. Other elements such as

**Figure 44**  
**Corrosion of Steels in Crude Oil Containing Naphthenic Acid and Sulfur Compounds**

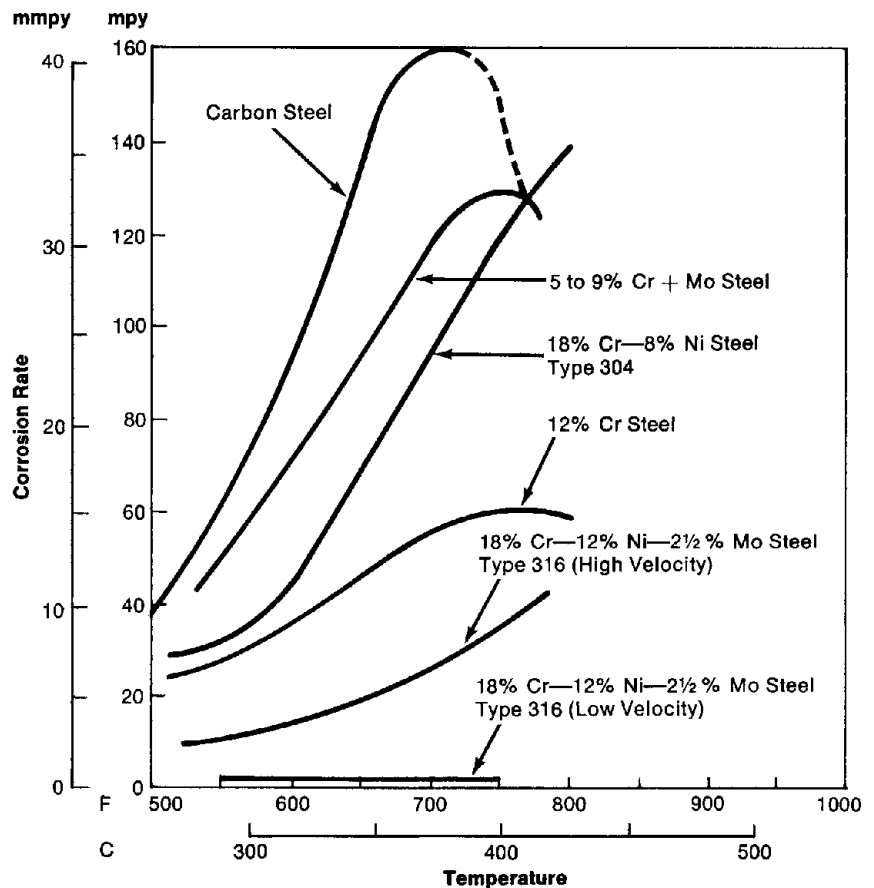

Source: Climax Molybdenum Company (24)

**Figure 46**  
**Comparative Scaling Behavior of Various Steels**  
**During 1000-Hr Exposures in Air at Temperatures**  
**from 1100 to 1700 F (595 to 925 C)**

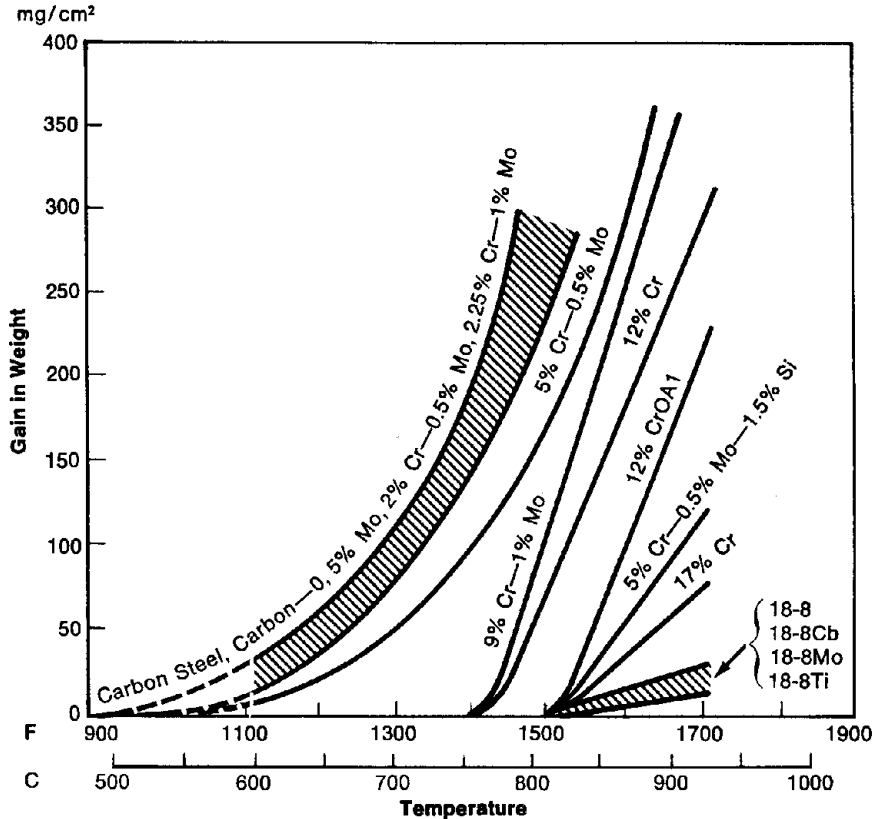

Source: Smith (25)

silicon and aluminum also increase scaling resistance, particularly when added to a steel containing chromium. Nickel imparts high-temperature strength, metallurgical stability (ductility), and an added small measure of high-temperature corrosion resistance.

Figure 46 provides an indication of the relative scaling resistance of commonly used high-temperature alloy steels.

Stainless steels containing less than 18% chromium are limited to temperatures below 1500F (816C). Those containing 18-20% chromium are useful to temperatures of 1800F (982C), while adequate resistance to scaling at temperatures up to 2000F (1093C) requires a chromium content of at least 25%, such as Types 309 and 310. The maximum service temperature, based on an oxidation rate of 10 mg per sq cm in 1000 hours, is given for several stainless steels in Table 8. Steam will increase the oxidation rate.

For conditions in which temperatures vary, temperature limits are shown in Table 8 in the column "Intermittent Service."

Additions of silicon also increase resistance to oxidation, such as Type 314, but silicon tends to decrease high-temperature strength.

### Sulfidation

Sulfur attack is second only to air oxidation in frequency of occurrence and is of even greater consequence because deterioration is likely to be more severe.

Like oxidation, sulfidation proceeds by converting metal to scale, which may be protective, except that sulfide scales are friable and tend to exfoliate, exposing bare metal to further sulfidation (Figure 47).

As with oxidation, resistance to sulfidation relates to chromium content. Unalloyed iron will be converted rather rapidly to iron sulfide scale, but when alloyed with chromium and nickel, sulfidation resistance is enhanced – as illustrated by Figure 3. Silicon also affords some protection to sulfidation.

**Figure 47**  
*Lower wrench was exposed in refinery equipment to a high-sulfur environment. The resulting sulfidation was nonprotective as the sulfide scale tended to exfoliate.*

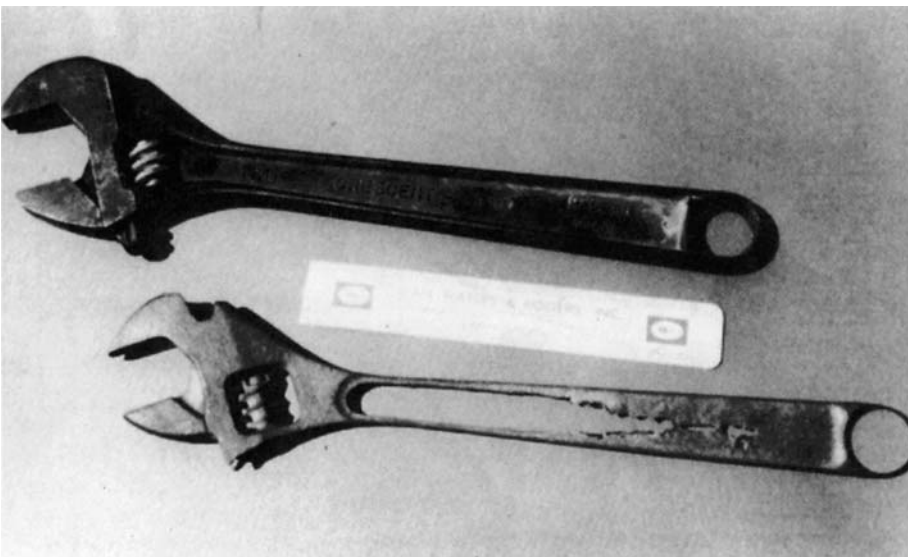



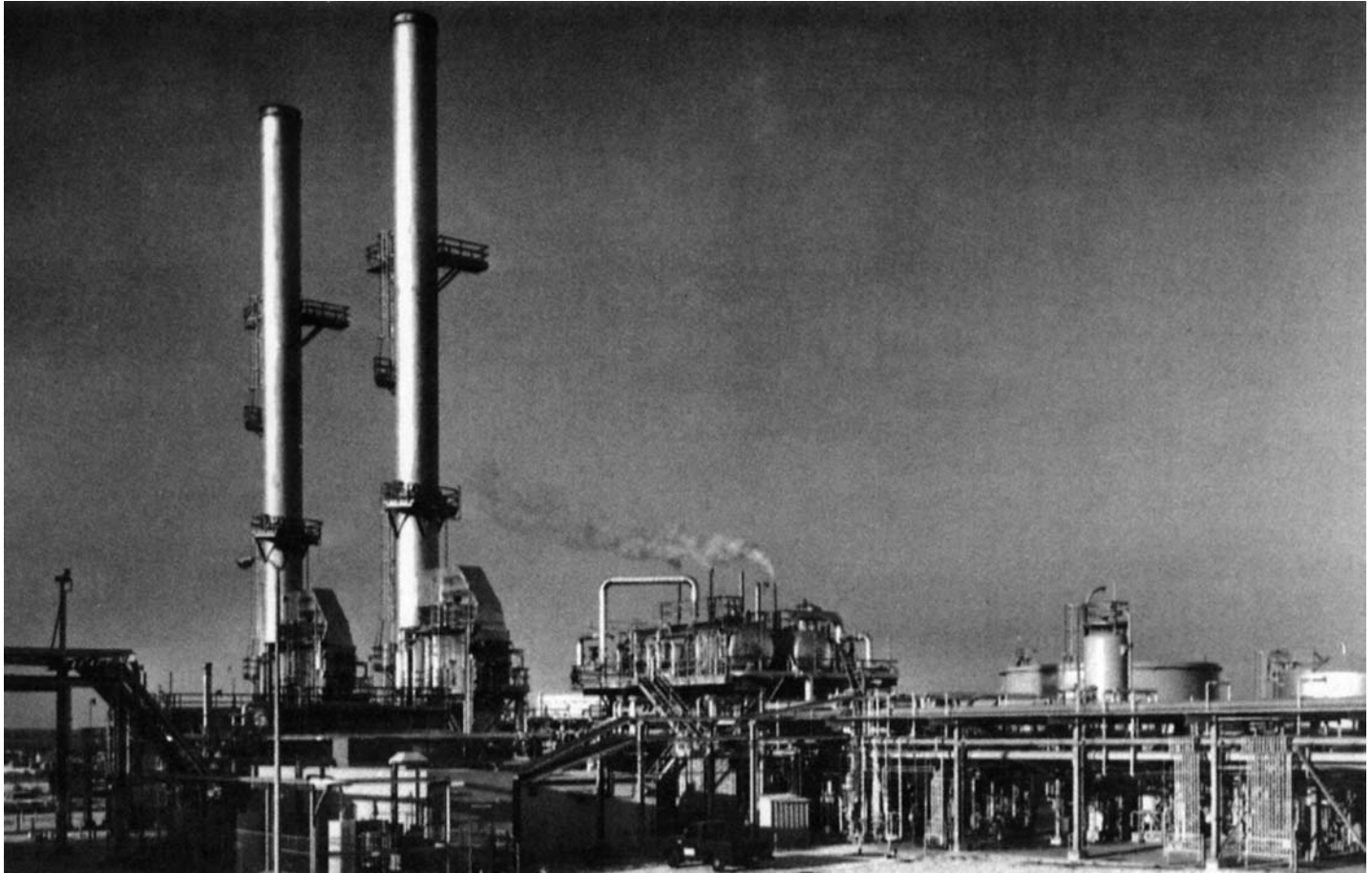

*Utility boilers serving the Marathon Oil Company Garyville Refinery.*

*Photograph: Marathon Oil Company  
Ralph M. Parsons Company*

In addition to the usual factors of time, temperature, and concentration, sulfidation depends upon the form in which the sulfur exists. An alloy possessing useful resistance to sulfur in one form may actually experience accelerated corrosion when the sulfur is present in another form. Of particular interest is the effect of hydrogen sulfide (H<sub>2</sub>S).

Hydrogen Sulfide. The rate of corrosion in H<sub>2</sub>S depends on concentration, temperature, pressure and permeability of the sulfide scale. The presence of chromium in the steel helps to stabilize the scale and slow the diffusion process. However, at high pressure and temperature, such as in catalytic reforming and desulfurization when hydrogen is present, the character of attack is considerably modified, to the

<b>TABLE 8</b>				
<b>Maximum Service Temperatures for Satisfactory Use Under Oxidizing Conditions Without Excessive Scaling (9)*</b>				
<b>AISI Type*</b>	<b>Continuous Service</b>		<b>Intermittent Service</b>	
	<b>C</b>	<b>F</b>	<b>C</b>	<b>F</b>
304	925	1700	870	1600
308	980	1800	925	1700
309	1095	2000	980	1800
310	1150	2100	1035	1900
316	925	1700	870	1600
317	925	1700	870	1600
321	925	1700	870	1600
330	1150	2100	1035	1900
347	925	1700	870	1600
405	705	1300	815	1500
410	705	1300	815	1500
430	815	1500	870	1600

\* The temperature limits shown may have to be revised downward in the presence of combustion products or gases high in sulfur compounds and if vanadium-containing ash is present.

Figure 48

### Sulfide Corrosion Reaction

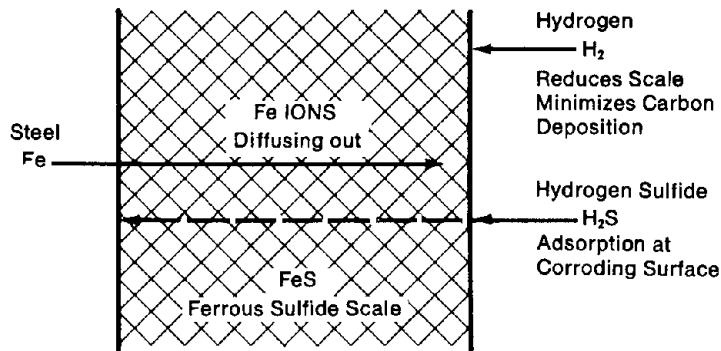
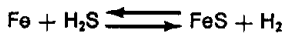

a

### Corrosion Rate Curves for H<sub>2</sub>/H<sub>2</sub>S Environments

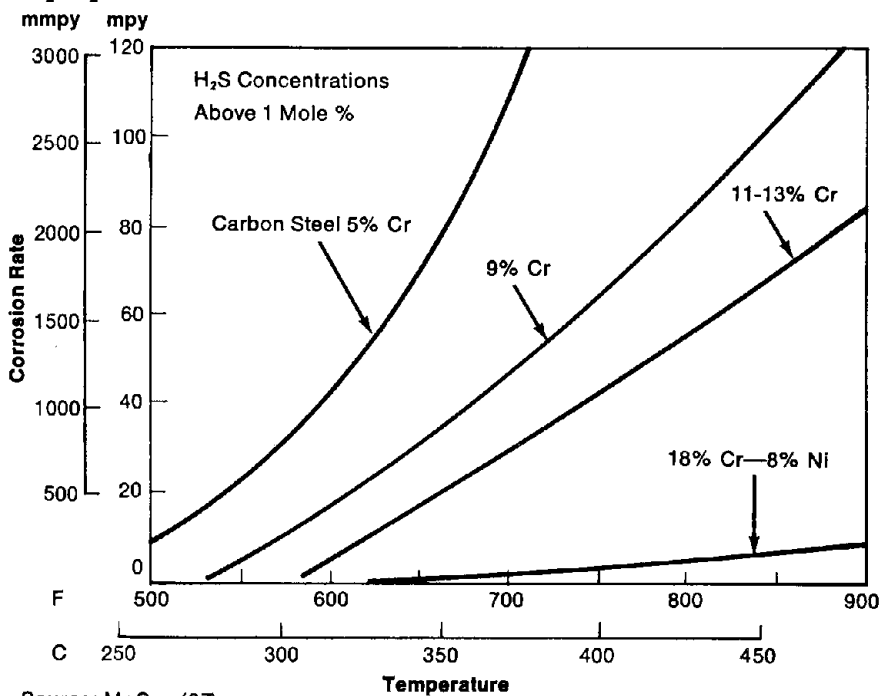

Source: McCoy (27)

b

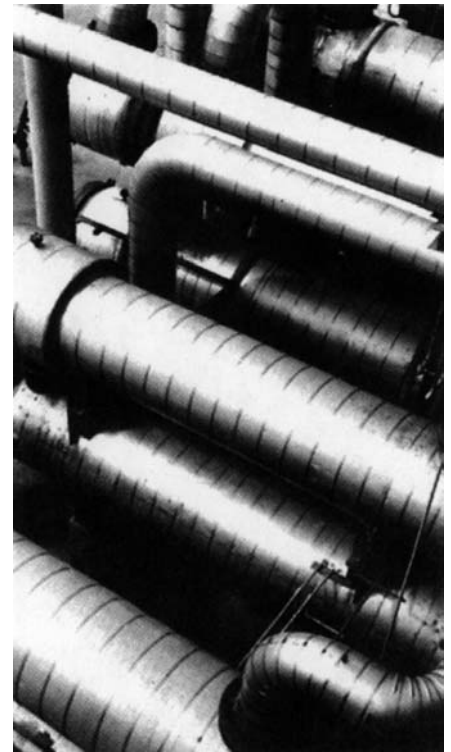

Type 304 stainless steel tubing in this feed-effluent heat exchanger operates at temperatures ranging from 300-600F (149-316C).

Photograph: Union Oil Company of California

resistance, and it has been established that stainless steels with 18-20% chromium and 8-20% nickel are the most desirable for long-term service. McCoy (27) confirms this by data resulting from laboratory tests in which steels were evaluated in flowing H<sub>2</sub>/H<sub>2</sub>S gas. The conditions for these tests ranged from 500-900F (260-480C), 15-2015 psia (0.10-13.9 MPa), and time intervals varying up to 2515 hours. Figure 48a shows the concept of hydrogen penetration and 48b shows corrosion rates for H<sub>2</sub>S concentrations above one mole percent. Each curve represents the maximum rate of corrosion that would be expected under commercial operating conditions.

The McCoy tests also showed that the rate of attack above 500F (260C) – at low H<sub>2</sub>S partial pressure – was dependent upon both pressure and temperature. However, above about 6 psi H<sub>2</sub>S partial pressure, only temperature affected the rate of attack.

Test runs involving benzene and decanted oil resulted in lower rates, perhaps because of coking (Figure 49).

extent that low-chromium steels are not adequate (26).

The system pressure increases the H<sub>2</sub>S partial pressure, making it more reactive. Molecular hydrogen dissociates slightly to provide atomic hydrogen, which is more reactive and can diffuse through steel. The hydrogen combines with the sulfide scale, reducing it and creating a porous

structure through which the iron and sulfur ions can maintain high diffusion rates. Also, hydrogen suppresses the formation of coke deposits that can act as effective corrosion barriers.

In the case of the iron-chromium alloys, resistance to H<sub>2</sub>S attack decreases up to 5-9% chromium. However, higher chromium content and the addition of nickel improve

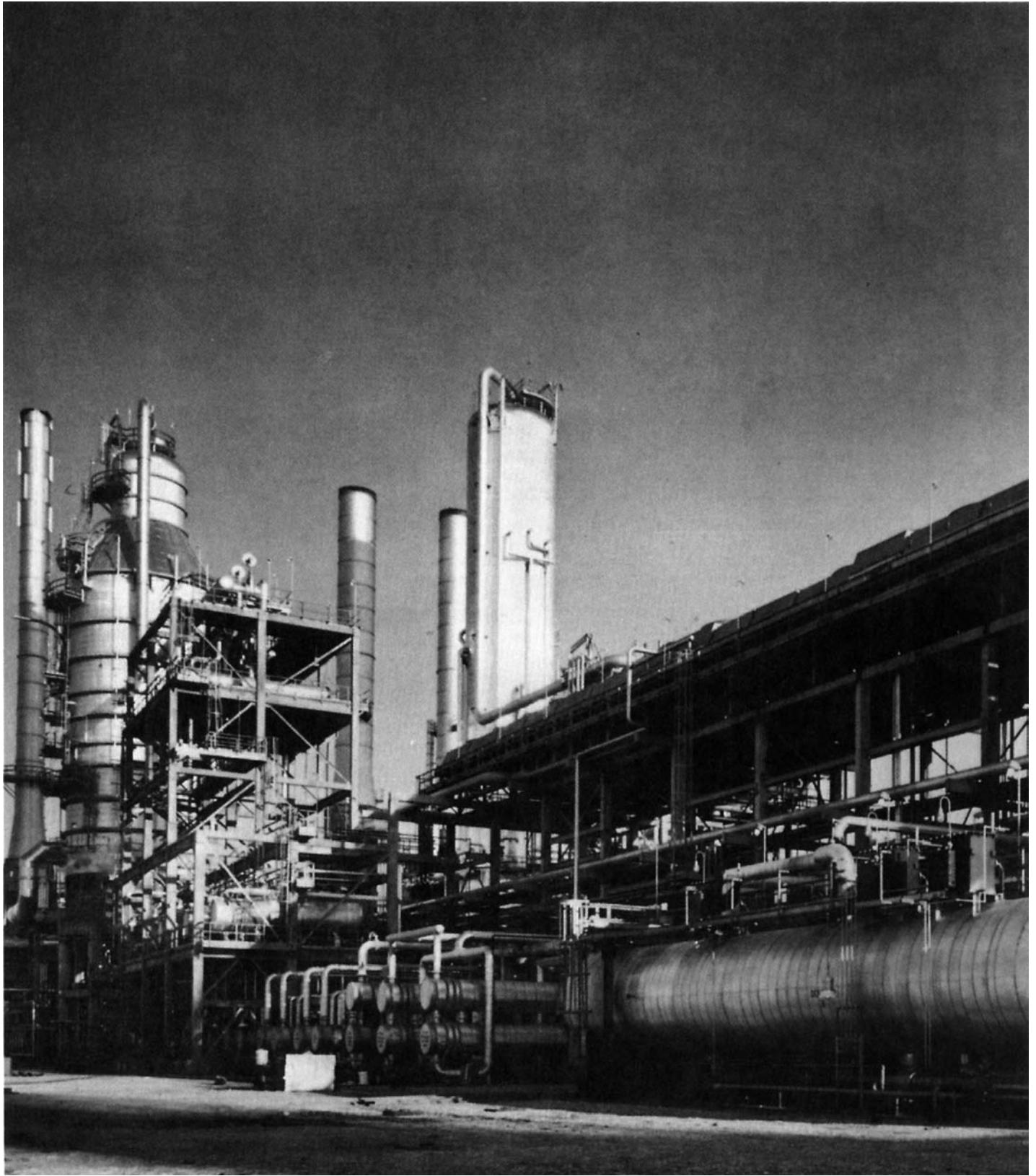

*Crude unit desalters at the Marathon Oil Company Garyville Refinery. The crude vacuum tower is shown at the left.*

*Photograph: Marathon Oil Company  
Ralph M. Parsons*

Figure 49  
**Corrosion of Type 321 Stainless Steel  
 in Mixed Gas and Oil Environments**

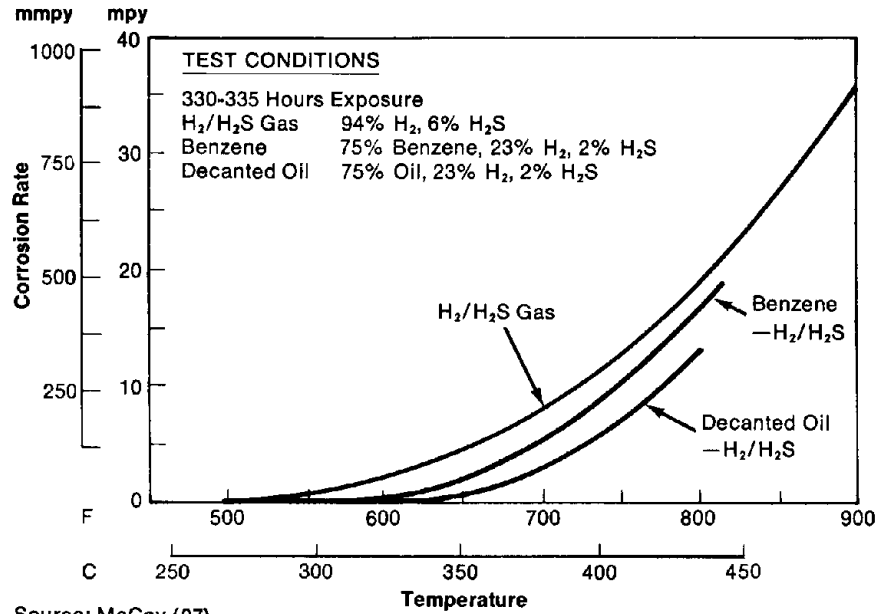

Source: McCoy (27)

### 885F and Sigma-Phase Embrittlement

Ferritic stainless steels are subject to embrittlement when exposed to temperatures of 700-950F (371-510C) over an extended period of time. Martensitic stainless steels with 12% chromium occasionally have been known to display brittle tendencies after extended periods in the same temperature range (28). This phenomenon is called 885F (475C) embrittlement because that is the temperature at which embrittlement is most pronounced.

Figure 50a shows the embrittling range peaking at 885F (475C) for three time periods; 400, 1000, and 5000 hours, and Figure 50b shows that 885F (475C) embrittlement increases with time and chromium content.

885F (475C) embrittlement results in low ductility, poor impact strength, and increased hardness and tensile strength at room temperature. At room temperature the alloy may fracture if not handled carefully. (Hitting with a

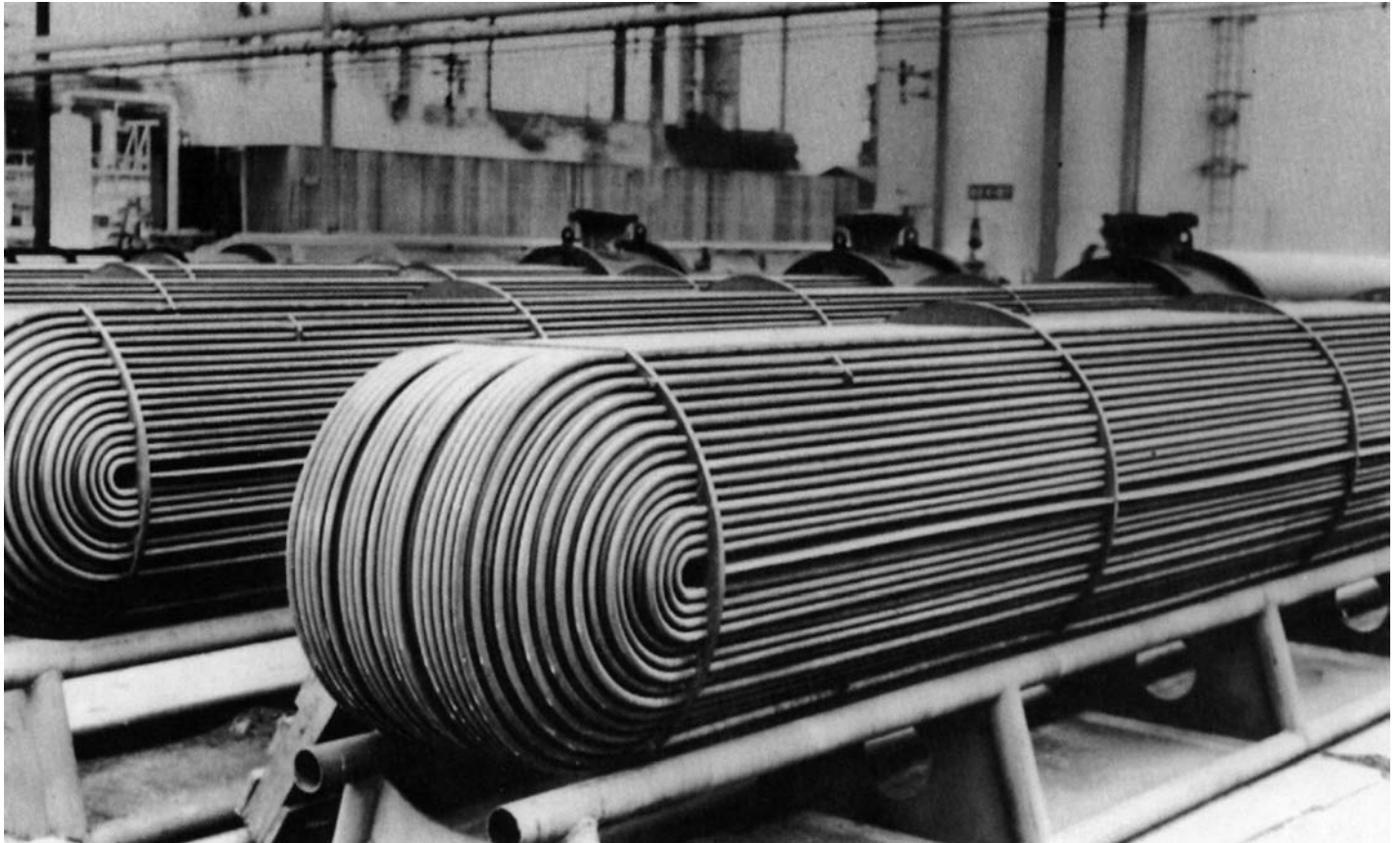

*U-tube heat exchanger bundle for petroleum refining. Tubes and support grids are stainless steel.*

hammer, for example, might cause a fracture.) The alloy however, retains its desirable mechanical properties at operating temperatures, 500F (260C) and higher. Embrittlement can be removed by heat treatment at 1100F (593C) or above, followed by air cooling.

Ferritic stainless steels are also subject to sigma-phase embrittlement when exposed to temperatures of 1000-1600F (538-871 C) over extended periods of time. It results in a loss of ductility at room temperature. Sigma-phase embrittlement can be removed by heat treatment at 1850F (1010C) followed by air cooling.

### Carburization

Carburization is defined as diffusion of excessive amounts of carbon into a metal to such a degree as to form high-carbon alloys with little ductility at ambient temperatures. The chromium carbides thus formed are prone to rapid oxidation under oxidizing conditions and the virtual disappearance of the metal carbides leaving deep holes. Such an extension of carburization, which is relatively uncommon, is known as metal dusting.

Carburization is caused by continuous overheating of a metal in the presence of hydrocarbon gases, carbon monoxide or coke.

Carburization is found most often in petroleum refineries in the fired heater tubes of delayed cokers. It is very common in the pyrolysis furnaces of ethylene plants. It has been observed in structural components of low-chromium steels in the top of fluid catalytic cracker regenerators and in overheated carbon steel tubing in naphtha furnaces.

Laboratory and field experience indicate that carburization seems to depend on chromium content (29). For example, a comparison of the carbon absorbed by Type 430, on the one hand, and Type 446 under identical conditions shows that in the higher chromium alloy the diffusion rate is much slower. Higher nickel content is also effective, such as in Type 310 as compared to Types 309 or 304. Silicon is also effective in preventing carbon absorption, such as in Types 302B and 314.

### Hydrogen Attack

Atomic hydrogen, which results from a

Figure 50  
885 F Embrittlement

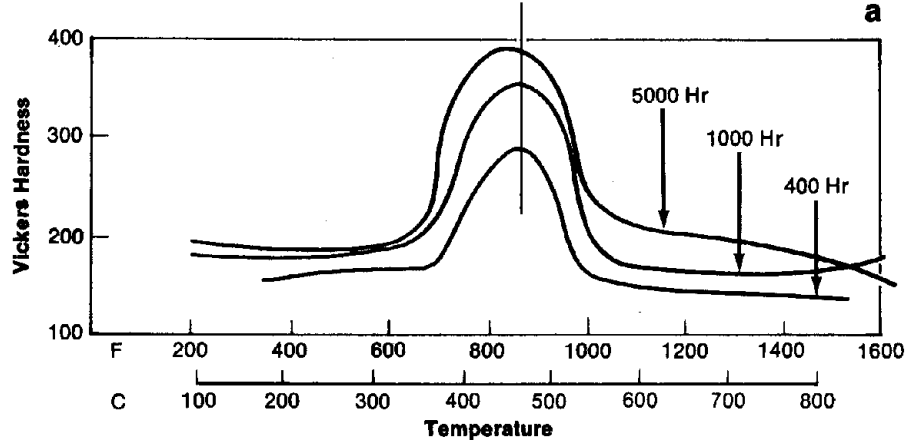

Graph of Hardness Versus Aging Temperature for 400 Hours, 1000 Hours and 5000 Hours, Using 27% Chromium Steel—Type 446.

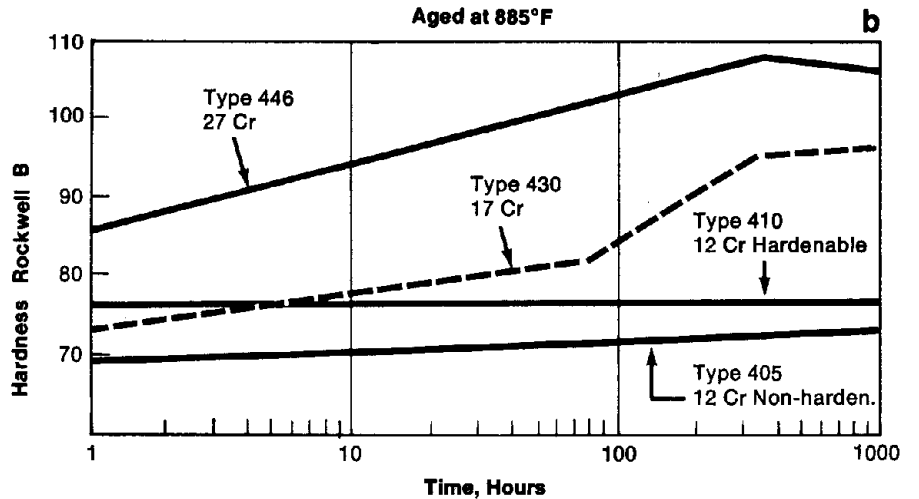

Graph of Hardness Versus Aging Time in Hours for Types 446, 430, 410 and 405 Chromium Steels. Hardening Tendency Increases with Chromium Content. Aged at 885°F.

Source: Moller (28)

corrosion reaction or the dissociation of molecular hydrogen, can diffuse rapidly through the steel lattice to voids, imperfections or low-angle grain boundaries. There the diffusing atoms accumulate and combine to form molecular hydrogen or, at high temperature, react with carbon to form methane. The larger hydrogen or methane molecules are trapped, and the subsequent pressure buildup results in blisters or laminations (hydrogen damage) and/or degradation of ductility

(hydrogen embrittlement). Eventually the steel cracks and may become unsuitable for continued use. In low-temperature environments, carbon or low-alloy steels are usually suitable, but for temperatures above 800F (425C) and at high pressures (about 10,000 psi, 69 MPa), the austenitic stainless steels have sufficient chromium to impart good resistance to hydrogen attack. They are useful at all temperatures and pressures considered in the comprehensive works of Nelson (30). The cladding and internal

components of hydrocracker reactors are made of Types 347, 309 and 308, combining a high degree of sulfidation resistance with a high level of resistance to hydrogen attack.

## COOLING WATER TYPES

### Fresh Water

In fresh water as found in virtually all inland locations in the United States and Canada, it can be said that clean stainless steel heat exchanger tubing resists all forms of corrosive attack. However, there have been some reports of stainless steel tubing failures in fresh water, but such reports are rare. The total amount of stainless steel tubing that has failed in electric utility cooling condensers, for example, (including salt water applications) is approximately 1/2 of 1 per cent, which is exceptionally low considering the many millions of feet of tubing in service.

Investigations of reported failures revealed that most were preventable. The principal problem was dirty tubes. Chlorides were allowed to concentrate under spotty conditions of fouling, resulting in localized corrosion.

Corrosion engineers describe the fouling as occurring in two ways; as a solid continuous coating on the tube surface, or as small isolated or localized spots. Conditions underneath continuous fouling are generally uniform and not considered serious to stainless steel in fresh water, whereas, spotting or localized fouling can create concentration cells that are potential corrosion sites.

### Polluted Fresh Water

There are no hard and fast rules on the ability of stainless steels to stand up in polluted water because of the variety and nature of pollutants that can be involved. If the pollutants are in the form of sewerage, stainless steels can be used, since they are resistant to hydrogen sulfide, ammonia, and carbon dioxide. They are used extensively in sewage treatment plants. If the pollutants are effluents containing chemical wastes, which is becoming more unlikely today because of tightening pollution control regulations, then each situation should be studied and tests conducted. In all probability, chemical wastes will be

sufficiently diluted to permit the use of stainless steels.

### Polluted Salt Water

Where polluted salt water has been used for cooling, stainless steels have demonstrated greater reliability than copper-base alloys under circumstances of abnormally high sulfide content. Sulfide attack of copper-base alloys is sufficiently rapid and certain to make failures from this cause far more important than an occasional failure of stainless steel by chloride-induced pitting. Furthermore, the danger of chloride pitting can be minimized in brackish water by using Type 316, 317, or one of the higher alloyed stainless steels – and by avoiding or preventing the accumulation of localized deposits that are potential pitting sites.

For example, 6X and Nitronic 50 have been proven effective in severely polluted brackish water. In one test, conducted by a stainless steel producer at an electric utility, condenser tubes of stainless steel 6X were partially plugged to adjust cooling water velocity to one foot (0.305m) per second and even to 1/10 (0.0305m) foot per second. On removal after 18 months, heavy fouling was observed but no corrosion.

Ferritic stainless steels under development, specifically 29-4 and 29-4-2, would be very resistant to polluted or non-polluted brackish water.

### Fresh Salt Water

Stainless steel in sea water is another story altogether. Some electric utilities have documented success with Type 316 but only with continuous or periodic cleaning to prevent fouling. Spotty or continuous fouling in sea water leads to failure by pitting. An alternative is one of the higher alloyed stainless steels, which may be more economically attractive than titanium.

### Cooling Towers

Water conservation has resulted in many refineries using cooling towers. From the standpoint of potential corrosion problems, towers can be both an asset as well as a liability.

Because cooling tower water is recirculated, the plant can exercise some control over water quality by the

use of pH control, chemicals to prevent scale, and corrosion inhibitors. With once-through cooling, such control is out of the question because of the costly treatment of huge quantities of water and newly enforced water pollution regulations.

On the other hand, cooling towers concentrate the total dissolved salts occurring in the feed water, including chlorides. Both Types 304 and 316 have been used successfully in cooling tower water situations when the chloride level is relatively low (500 ppm) and the exchangers remain relatively clean, or when corrosion inhibitors have been used in the water treatment program to protect steel heat exchanger tubing and steel piping.

If new EPA regulations result in cessation of the more reliable chromate-base corrosion inhibitors, then in some applications it may be required to upgrade from 304 to 316, 317, or one of the proprietary stainless alloys to avoid pitting corrosion under deposits.

To summarize the discussion of cooling water types:

1. Stainless steels have been used successfully in virtually all cooling waters. For most cases below 500 ppm chlorides, Type 304 might be used; for sea water, higher alloyed stainless steels containing molybdenum are a better choice.
2. Cooling tower waters are expected to be more troublesome in the future as water conservation dictates more cycles of concentration and cut-backs of traditional corrosion inhibitors. However, stainless steels will continue to be used with reliance on the higher molybdenum grades.
3. For any material, cleanliness insures improved heat exchange and reduces risk of localized corrosion.

*Desulfurization facilities at the Garyville Refinery include a 33,000 BPD light gas oil Hydrobon unit and a heavy gas oil Hydrobon unit of 53,500 BPD capacity.*

*Photograph: Marathon Oil Company  
Ralph M. Parsons Company*

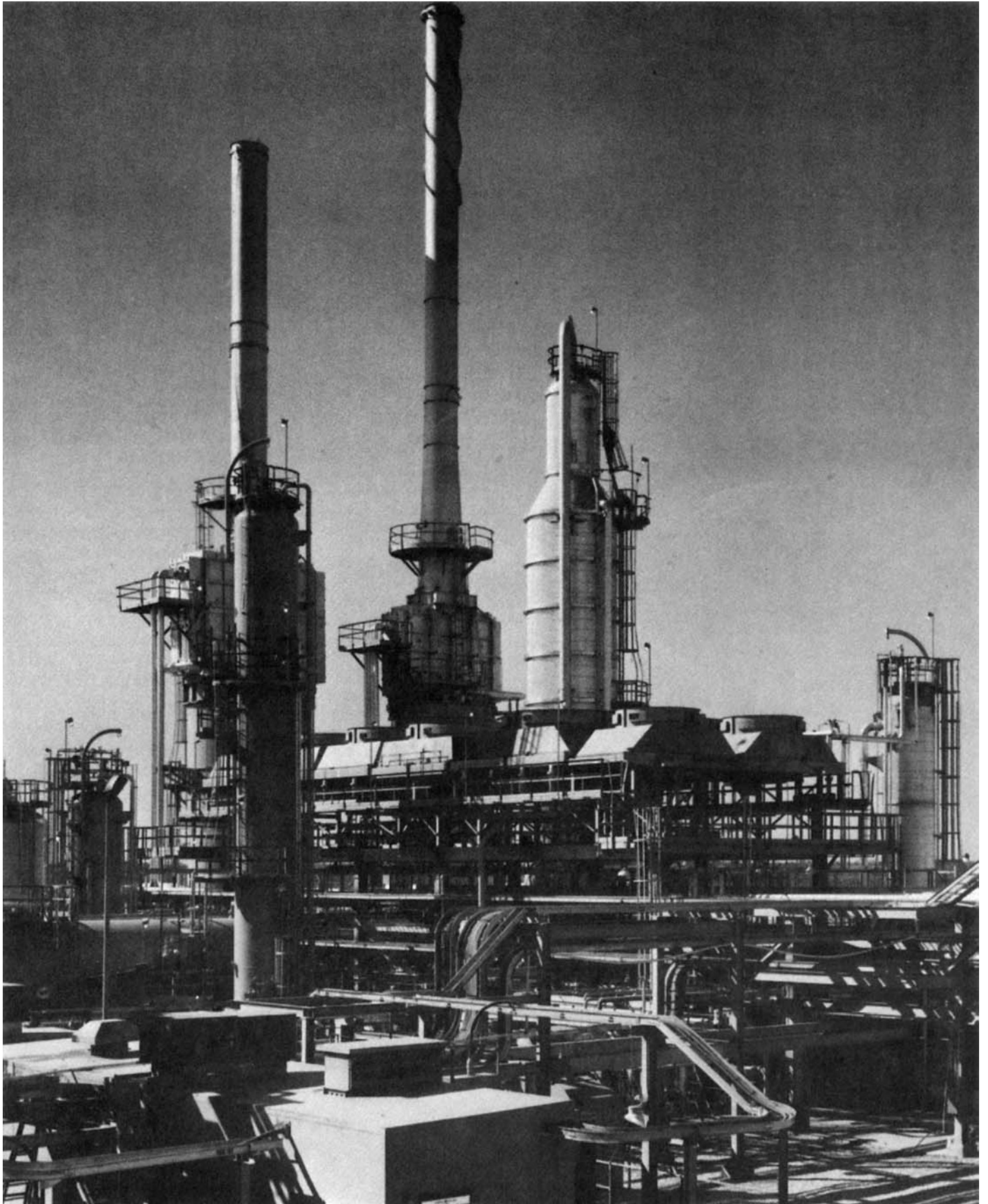

## REFERENCES

1. H. F. McConomy "High-Temperature Sulfidic Corrosion in Hydrogen-Free Environment," Proceedings of the American Petroleum Institute, Refining Division, Section 3, 1963.
2. R. L. Piehl, "Stress Corrosion Cracking by Sulfur Acids," Proceedings of the American Petroleum Institute, Refining Division, Section 3, 1964.
3. C. H. Samans, "Stress-Corrosion Cracking Susceptibility of Stainless Steels and Nickel-Base Alloys in Polythionic Acids and Acid Copper Sulfate Solution," CORROSION, August 1964.
4. J. S. Heller and G. R. Prescott, "Cracking of Stainless Steels in Wet Sulfidic Environments in Refinery Units," MATERIALS PROTECTION, September 1965.
5. R. L. Piehl, "Corrosion by Sulfide-Containing Condensate in Hydrocracker Effluent Coolers," Proceedings of the American Petroleum Institute, Refining Division, Section 3, 1968.
6. A. M. Alvarez and C. A. Robertson, "Materials and Design Considerations in High Pressure HDS Effluent Coolers," MATERIALS PROTECTION AND PERFORMANCE, Vol. 12, No. 5, May 1973.
7. R. L. Piehl, "Survey of Corrosion in Hydrocracker Effluent Air Coolers," MATERIALS PROTECTION AND PERFORMANCE, January 1976.
8. W. A. Bonner, et al: "Prevention of Hydrogen Attack on Steel in Refinery Equipment," Proceedings of the American Petroleum Institute, Refining Division, Section 3, 1953.
9. Stainless Steel Industry Data.
10. M. G. Fontana, "Corrosion Series," INDUSTRIAL ENGINEERING CHEMISTRY, 44, March 1952.
11. Steel Products Manual, "Stainless and Heat Resisting Steels," December 1974, American Iron and Steel Institute, Washington, D.C.
12. ASME Boiler and Pressure Vessel Code, Section VIII, 1974, Division 1.
13. Simmons and Van Echo, "Report on the Elevated-Temperature Properties of Stainless Steels," ASTM Data Series Publication DS-5-S1 (formerly Special Technical Publication No. 124).
14. Simmons and Cross, "Report on the Elevated-Temperature Properties of Chromium Steels, 12 to 27 Percent," ASTM Special Technical Publication 228.
15. "Mechanical and Physical Properties of the Austenitic Chromium-Nickel Stainless Steels at Elevated Temperature." The International Nickel Company, Inca, New York, 1968.
16. Svetsaren English Edition 1-2, 1969.
17. H. L. Logan, "The Stress Corrosion of Metals," John Wiley & Sons.
18. G. E. Moller, "Designing With Stainless-Steels for Service in Stress-Corrosion Environments," NACE Paper No. 53, Houston, Texas, 1976.
19. H. R. Copson, "Effect of Composition on Stress-Corrosion Cracking of Some Alloys Containing Nickel, Physical Metallurgy of Stress-Corrosion Fracture," Interscience Publishers, New York, 1959.
20. H. H. Ulig and R. A. White, "Some Metallurgical Factors Affecting Stress-Corrosion Cracking of Austenitic Stainless Steels," Transcripts of ASK Vol. 52, 1960.
21. J. F. Lancaster, "What Causes Equipment to Fail?" HYDROCARBON PROCESSING, January 1976.
22. Republic Enduro Stainless Steels, Republic Steel Corporation, Cleveland, Ohio, 1951.
23. Standard Oil Company of California, Unpublished.
24. "A Review of Factors Affecting the Selection of Steels for Refining and Petrochemical Applications," Climax Molybdenum Company, Greenwich, Conn., 1971.
25. G. V. Smith, "Properties of Metals at Elevated Temperatures," McGraw-Hill Book Company, 1950.
26. B. W. Neumaier and C. M. Schillmoller, "How Richfield Plans to Combat High-Temperature Sulfide Corrosion," API Paper, May 1956, Montreal, Quebec, Canada.
27. J. D. McCoy, "Corrosion Rates for H<sub>2</sub>S at Elevated Temperatures in Refinery Hydrodesulfurization Processes," NACE Paper No. 128, Chicago, 1974.
28. G. E. Moller, "Experiences with 885F Embrittlement in Ferritic Stainless Steels," MATERIALS PROTECTION, MAY 1966.
29. "High-Temperature Corrosion in Refinery and Petrochemical Service," The International Nickel Company, February 1976, New York, N.Y.
30. "Steels for Hydrogen Service at Elevated Temperature and Pressure in Petroleum Refining and Petrochemical Plants," API Publication 941, American Petroleum Institute Division of Refining.



## ADDITIONAL REFERENCES

Frank L. Evans, et al: "Metallurgy for Process and Mechanical Design Engineers," HYDROCARBON PROCESSING, August 1972.

Steels for Elevated-Temperature Service, United States Steel Corporation, Pittsburgh, Pa.

B & W Stainless Croloy Steels, Bulletin T 411, Babcock & Wilcox Company, Beaver Falls, Pa.

C. M. Hudgins, Jr., "A Review of Sulfide Corrosion Problems in the Petroleum Industry," MATERIALS PROTECTION, January 1969.

A. R. Cuffreda and B. M. Greene, "Survey of Materials and Corrosion Experience in Reformer Hydrogen

Plants," Proceedings of the American Petroleum Institute, Division of Refining, 1972.

S. L. Esefan, "Design Guide to Metallurgy and Corrosion in Hydrogen Processes," HYDROCARBON PROCESSING, December 1970.

F A. Hendershot and H. L. Valentine, "Materials for Catalytic Cracking Equipment," MATERIALS PROTECTION, October 1967.

W. H. Sharp and E. W. Haycock, "Sulfide Scaling Under Hydrorefining Conditions," Proceedings of the American Petroleum Institute, Division of

Refining, 1959.

A. S. Couper and J. W. Gorman, "Computer Correlations to Estimate High Temperatures H<sub>2</sub>S Corrosion in Refinery Streams," MATERIALS PROTECTION AND PERFORMANCE, January 1971.

W. A. Derungs, "Naphthenic Acid Corrosion—An Old Enemy of the Petroleum Industry," CORROSION, December 1956.

1972 Survey of Materials Experience and Corrosion Problems in Sour Water Strippers, American Petroleum Institute, Division of Refining, API Publication 944, November 1974.



*Type 304 stainless steel tubing extends heat exchanger service life in hydrogen production. Photograph: Union Oil Company of California*